



DVD Navigation Unit

ENGLISH

Operation Manual

AVIC-8DVD

Pioneer

**The screen shown in the example may differ from the actual screen.
The actual screen may be changed without notice for performance and function
improvements.**

Introduction

License Agreement

■ PIONEER AVIC-8DVD

THIS IS A LEGAL AGREEMENT BETWEEN YOU, AS THE END USER, AND PIONEER CORP.(JAPAN) (“PIONEER”). PLEASE CAREFULLY READ THE TERMS AND CONDITIONS OF THIS AGREEMENT BEFORE USING THE SOFTWARE INSTALLED ON THE PIONEER PRODUCTS. BY USING THE SOFTWARE INSTALLED ON THE PIONEER PRODUCTS, YOU ARE AGREEING TO BE BOUND BY THE TERMS OF THIS AGREEMENT. THE SOFTWARE INSTALLED ON THE PIONEER PRODUCTS INCLUDES DATABASE OF NAVTECH Data OF Navigation Technologies Corporation (“NAVTECH”) AND SEPARATE TERMS ATTACHED SHALL BE APPLIED TO THE DATABASE BY THE NAVTECH Data BY NAVTECH RESPECTIVELY. IF YOU DO NOT AGREE WITH THESE TERMS, PLEASE RETURN THE PIONEER PRODUCTS (INCLUDING THE SOFTWARE AND ANY WRITTEN MATERIALS) WITHIN FIVE (5) DAYS OF RECEIPT OF THE PRODUCTS, TO THE PLACE FROM WHICH YOU PURCHASED THEM, FOR A FULL REFUND OF THE PURCHASE PRICE OF THE PIONEER PRODUCTS.

1. GRANT OF LICENSE

Pioneer grants to you a non-transferable, non-exclusive license to use the software installed on the Pioneer products (the “Software”) and the related documentation solely for your own personal use or for internal use by your business, only on such Pioneer products.

You shall not copy, reverse engineer, translate, port, modify or make derivative works of the Software. You shall not loan, rent, disclose, publish, sell, assign, lease, sublicense, market or otherwise transfer the Software or use it in any manner not expressly authorized by this agreement. You shall not derive or attempt to derive the source code or structure of all or any portion of the Software by reverse engineering, disassembly, decompilation, or any other means. You shall not use the Software to operate a service bureau or for any other use involving the processing of data for other persons or entities.

Pioneer and its licensor(s) shall retain all copyright, trade secret, patent and other proprietary ownership rights in the Software. The Software is copyrighted and may not be copied, even if modified or merged with other products. You shall not alter or remove any copyright notice or proprietary legend contained in or on the Software.

You may transfer all of your license rights in the Software, the related documentation and a copy of this License Agreement to another party, provided that the party reads and agrees to accept the terms and conditions of this License Agreement.

2. DISCLAIMER OF WARRANTY

The Software and related documentation are provided to you “AS IS”. PIONEER AND ITS LICENSOR(S) (for the purpose of provisions 2 and 3, Pioneer and its licensor(s) shall be collectively referred to as “Pioneer”) MAKES AND YOU RECEIVE NO WARRANTY, WHETHER EXPRESS OR IMPLIED, AND ALL WARRANTIES OF MERCHANTABILITY AND FITNESS FOR ANY PARTICULAR PURPOSE ARE EXPRESSLY EXCLUDED. SOME STATES DO NOT ALLOW EXCLUSION OF IMPLIED WARRANTIES, SO THE ABOVE EXCLUSION MAY NOT APPLY TO YOU. The Software is complex and may contain some non-conformities, defects or errors. For example, the voice recognition function as implemented by the Software may not recognize your voice. Pioneer does not warrant that the Software will meet your needs or expectations, that operation of the Software will be error free or uninterrupted, or that all non-conformities can or will be corrected. Furthermore, Pioneer does not make any representations or warranties regarding the use or results of the use of the Software in terms of its accuracy, reliability or otherwise.

3. LIMITATION OF LIABILITY

IN NO EVENT SHALL PIONEER BE LIABLE FOR ANY DAMAGES, CLAIM OR LOSS INCURRED BY YOU (INCLUDING, WITHOUT LIMITATION, COMPENSATORY, INCIDENTAL, INDIRECT, SPECIAL, CONSEQUENTIAL, OR EXEMPLARY DAMAGES, LOST PROFITS, LOST SALES OR BUSINESS, EXPENDITURES, INVESTMENTS, OR COMMITMENTS IN CONNECTION WITH ANY BUSINESS, LOSS OF ANY GOODWILL, OR DAMAGES) RESULTING FROM THE USE OF OR INABILITY TO USE THE SOFTWARE, EVEN IF PIONEER HAS BEEN INFORMED OF, KNEW OF, OR SHOULD HAVE KNOWN OF THE LIKELIHOOD OF SUCH DAMAGES. THIS LIMITATION APPLIES TO ALL CAUSES OF ACTION IN THE AGGREGATE, INCLUDING WITHOUT LIMITATION BREACH OF CONTRACT, BREACH OF WARRANTY, NEGLIGENCE, STRICT LIABILITY, MISREPRESENTATION, AND OTHER TORTS. IF PIONEER’S WARRANTY DISCLAIMER OR LIMITATION OF LIABILITY SET FORTH IN THIS AGREEMENT SHALL OR FOR ANY REASON WHATSOEVER BE HELD UNENFORCEABLE OR INAPPLICABLE, YOU AGREE THAT PIONEER’S LIABILITY SHALL NOT EXCEED FIFTY PERCENT (50%) OF THE PRICE PAID BY YOU FOR THE ENCLOSED PIONEER PRODUCT.

Some states do not allow the exclusion or limitation of incidental or consequential damages, so the above limitation or exclusion may not apply to you. This warranty disclaimer and limitation of liability shall not be applicable to the extent that any provision of this warranty is prohibited by any federal, state or local law which cannot be preempted.

4. EXPORT LAW ASSURANCES

You agree and certify that neither the Software nor any other technical data received from Pioneer, nor the direct product thereof, will be exported outside the country or district (the “Country”) governed by the government having jurisdiction over you (the “Government”) except as authorized and as permitted by the laws and regulations of the Government. If the Software has been rightfully obtained by you outside of the Country, you agree that you will not re-export the Software nor any other technical data received from Pioneer, nor the direct product thereof, except as permitted by the laws and regulations of the Government and the laws and regulations of the jurisdiction in which you obtained the Software.

5. TERMINATION

This Agreement is effective until terminated. You may terminate it at any time by destroying the Software. The Agreement also will terminate if you do not comply with any terms or conditions of this Agreement. Upon such termination, you agree to destroy the Software.

6. MISCELLANEOUS

This is the entire Agreement between Pioneer and you regarding its subject matter. No change in this Agreement shall be effective unless agreed to in writing by Pioneer. If any provision of this Agreement is declared invalid or unenforceable, the remaining provisions of this Agreement shall remain in full force and effect.

■ **TERMS AND CONDITIONS for the NAVTECH Data**

THIS IS A LEGAL AGREEMENT (“AGREEMENT”) BETWEEN YOU, THE END USER, AND NAVIGATION TECHNOLOGIES CORPORATION (NAVTECH) AND ITS SUPPLIERS, THE TERMS AND CONDITIONS OF WHICH ARE SET FORTH BELOW. BY USING YOUR COPY OF THE NAVTECH DATA, YOU AGREE TO THE TERMS AND CONDITIONS OF THIS AGREEMENT.

Personal Use Only. You are granted a non-exclusive, personal license to use this information solely for your personal, non-commercial purposes, and not for service bureau, time-sharing or other similar purposes. You may make one copy of the NAVTECH Data for archival or backup purposes only. You may not otherwise reproduce, copy, modify, decompile, disassemble or reverse engineer any portion of the NAVTECH Data, and may not transfer or distribute it in any form, for any purpose.

Ownership. You acknowledge that the NAVTECH Data, related documentation and other proprietary rights therein are owned by NAVTECH and/or its suppliers. All rights not expressly granted in this Agreement are expressly retained by and for NAVTECH and its suppliers.

No Warranty. This NAVTECH Data is provided to you “as is,” and you agree to use it at your own risk. NAVTECH and its licensors (and their licensors and suppliers) make no guarantees, representations or warranties of any kind, express or implied, arising by law or otherwise, including but not limited to, content, quality, accuracy, completeness, effectiveness, reliability, fitness for a particular purpose, usefulness, use or results to be obtained from the NAVTECH Data.

Disclaimer of Warranty: NAVTECH AND ITS LICENSORS (INCLUDING THEIR LICENSORS AND SUPPLIERS) DISCLAIM ANY WARRANTIES, EXPRESS OR IMPLIED, OF QUALITY, PERFORMANCE, MERCHANTABILITY, FITNESS FOR A PARTICULAR PURPOSE OR NON-INFRINGEMENT. Some States, Territories and Countries do not allow certain warranty exclusions, so to that extent the above exclusion may not apply to you.

Disclaimer of Liability: NAVTECH AND ITS LICENSORS (INCLUDING THEIR LICENSORS AND SUPPLIERS) SHALL NOT BE LIABLE TO YOU: IN RESPECT OF ANY CLAIM, DEMAND OR ACTION, IRRESPECTIVE OF THE NATURE OF THE CAUSE OF THE CLAIM, DEMAND OR ACTION ALLEGING ANY LOSS, INJURY OR DAMAGES, DIRECT OR INDIRECT, WHICH MAY RESULT FROM THE USE OR POSSESSION OF THE NAVTECH DATA; OR FOR ANY LOSS OF PROFIT, REVENUE, CONTRACTS OR SAVINGS, OR ANY OTHER DIRECT, INDIRECT, INCIDENTAL, SPECIAL OR CONSEQUENTIAL DAMAGES ARISING OUT OF YOUR USE OF OR INABILITY TO USE THE NAVTECH DATA, ANY DEFECT IN THE NAVTECH DATA, OR THE BREACH OF THESE TERMS OR CONDITIONS, WHETHER IN AN ACTION IN CONTRACT OR TORT OR BASED ON A WARRANTY, EVEN IF NAVTECH OR ITS LICENSORS HAVE BEEN ADVISED OF THE POSSIBILITY OF SUCH DAMAGES. Some States, Territories and Countries do not allow certain liability exclusions or damages limitations, so to that extent the above may not apply to you.

Limitation of Liability. Without limiting the foregoing, in no event shall NAVTECH’s and/or its suppliers’ liability to you for any cause under any theory exceed the amount paid by you for your copy of the NAVTECH Data.

Termination. NAVTECH and its suppliers may terminate this Agreement at any time upon your breach of any term of this Agreement. Upon any such termination, you shall return your copy of the NAVTECH Data and all related documentation to NAVTECH and/or its suppliers.

Export Control. You agree not to export from anywhere any part of the NAVTECH Data except in compliance with, and with all licenses and approvals required under, applicable export laws, rules and regulations.

Government End Users. If the NAVTECH Data is being acquired by or on behalf of the United States government or any other entity seeking or applying rights similar to those customarily claimed by the United States government, the Data is licensed with “Restricted Rights.” Utilization of the Data is subject to the restrictions specified in the “Rights in Technical Data and Computer Data” clause at DFARS 252.227-7013, or the equivalent clause for non-defense agencies. Manufacturer is Navigation Technologies Corporation, 10400 West Higgins Road, Rosemont, Illinois 60018.

Indemnity. You agree to indemnify, defend and hold NAVTECH and its licensors (including their respective licensors, suppliers, assignees, subsidiaries, affiliated companies, and the respective officers, directors, employees, shareholders, agents and representatives of each of them) free and harmless from and against any liability, loss, injury (including injuries resulting in death), demand, action, cost, expense, or claim of any kind or character, including but not limited to attorney’s fees, arising out of or in connection with any use or possession by you of the NAVTECH Data.

Entire Agreement. These terms and conditions constitute the entire agreement between NAVTECH (and its licensors, including their licensors and suppliers) and you pertaining to the subject matter hereof, and supersedes in their entirety any and all written or oral agreements previously existing between us with respect to such subject matter.

Governing Law. The above terms and conditions shall be governed by the laws of the Illinois [insert “Netherlands” where European NAVTECH data is used], without giving effect to (i) its conflict of laws provisions, or (ii) the United Nations Convention for Contracts for the International Sale of Goods, which is explicitly excluded. You agree to submit to the jurisdiction of Illinois [insert “The Netherlands” where European NAVTECH Data is used] for any and all disputes, claims and actions arising from or in connection with the information provided to you hereunder.

Table of Contents

Introduction	1
License Agreement	1
PIONEER AVIC-8DVD	1
TERMS AND CONDITIONS for the NAVTECH Data.....	4
Table of Contents	6
Important Safety Information	10
Notes Before Using the System	11
Precaution	11
About the main unit battery	13
How to Read This Manual	14
How to use this manual	14
Terminology.....	14

Chapter 1

Getting Started	15
Setup 1: Getting Ready for the Remote Controller	15
Selecting dipswitches	15
Inserting the batteries to the Remote Controller.....	16
Setup 2: Getting to Know the Components and What They Do	17
The Remote Controller	17
Microphone.....	19
Main unit	20
Setup 3: Installing the Program	22

Chapter 2

Basic Operation	25
Switching On and Off	25
Types of Menu	26
Main menu.....	26
Shortcut menu	27
Basic Navigation	28
How to Use the Map	34
How to view the map of the current location	34
Changing the scale of the map.....	37
Moving the map to the location you want to see	37

Chapter 3

Setting a Route to Your Destination	41
Basic Flow of Route Calculation	41
Selecting the country where you want to search	42
Perform the route calculation of the several route options, and select one	42
Route Calculation to Your Home Location or to Your Favourite Location	45
Selecting your Destination from the Address Book	45
Searching for your Destination by Address	46
Specifying an Intersection as Your Destination	48
Finding Your Destination by Selecting the Type of Facility	49
Searching for Points of Interest (POI)	49
Finding POI in your surroundings or around the cross pointer	50
Finding Your Destination by Specifying the Postal Code	51
Setting an Entrance or Exit of a Motorway as Your Destination	52

Chapter 4

Guidance to Your Destination	53
Route Guidance by Your Navigation System	53
Route guidance by display and voice	53
When receiving traffic information ahead on the set route	54
Checking the Suggested Route	56
Checking the Suggested Route from the Information menu	56
Recalculating the Route to Your Destination	57
Cancelling the Route Guidance	58
Delete the current route, and cancel the route guidance	58
Changing your destination	58
Adding Via Points to the Current Route	59
Adding a via point	59
Skipping a via point.....	60
Deleting a via point from the route	60
Displaying Certain Points Of Interest on the Map	62

Chapter 5

Utilising Various Information	63
Editing the Address Book	63
Registering a previous location in the Address Book	63
Editing a location's information	65
Deleting the data in the Address Book	66
Confirming the location contained in the Address Book on the map	67
Registering Your Home and Your Favourite Location	68
Registering a location	68
Changing or deleting your home or your favourite location	70

Registering a Password	71
Setting Areas to Avoid	72
Registering an Area to Avoid.....	72
Changing or deleting an Area to Avoid.....	73
Using Traffic Information	74
Confirming traffic information relevant to the current route	74
Selecting the radio station	76
Using a PC Card	78
Initialising a PC card.....	78
Storing the data of registered locations in the PC card	78
Loading data from a PC card	79
Deleting PC card data	80
Checking the Navigation Status	81
Checking positioning information by satellite	81
Checking sensor learning status and driving status	82
Checking the connections of leads and installation positions	83

Chapter 6

Customising Your Navigation System	85
Modifying the Default Settings	85
Items Users can Change	86
Route Guidance menu	86
Map Display menu.....	88
Hardware menu.....	88
Others menu.....	88
RDS - TMC menu.....	90

Chapter 7

Operating Your Navigation System with Voice	91
Basics of Voice Operation	91
Available voice commands	92
An example of voice operation	92
Tips for Voice Operation	95

Appendix	97
Positioning Technology	97
Handling Large Errors	99
When the positioning by GPS is impossible	99
Conditions likely to cause noticeable positioning errors	100
Handling and Care of the Disc	101
Resetting the System	102
Troubleshooting	103
Messages and how to react to them	106
Route Setting Information	109
Route search specifications	109
Route highlighting	110
Intersection enlargement	110
Tracking	110
About traffic information	110
Copyright	111
Specifications	112
Glossary	113
Display Information	115

Important Safety Information

Before using your Navigation System, be sure to read and fully understand the following safety information:

- Read the manual before operating this Navigation System.
- This Navigation System is intended solely as an aid to you in the operation of your vehicle. It is not a substitute for your attentiveness, judgement, and care when driving.
- Do not operate this Navigation System if doing so in any way will divert your attention from the safe operation of your vehicle. Always observe safe driving rules and follow all existing traffic regulations.
- Never allow others to use the system unless they have read and understood the operating instructions.
- Never use this Navigation System to route to hospitals, police stations, or similar facilities in an emergency. The map data may not include a comprehensive list of emergency service facilities.
- Route and guidance information displayed by this equipment is for reference purposes only. It may not accurately reflect the latest permissible routes, road conditions, or traffic restrictions.
- Traffic restrictions and advisories currently in force should always take precedence over guidance given by this product. Always obey current traffic restrictions, even if this product provides contrary advice.
- Failure to input correct information about the local time may result in the product providing improper routing and guidance instructions.
- Never set the volume of your Navigation System so high that you cannot hear outside traffic and emergency vehicles.
- Keep your password secure and confidential. Knowledge of your password can give someone else access to personal information stored by the system, such as the history of destinations you have been to and your home address.
- To promote safety, certain functions are disabled unless the handbrake is on.
- The data encoded in the disc provided with this product is the intellectual property of the provider, and the provider is responsible for such content.
- As with any accessory in your vehicle's interior, you should not allow this Navigation System to divert your attention from the safe operation of your vehicle. If you experience difficulty in operating the system or reading the display, please make adjustments while safely parked.

Notes Before Using the System

■ Precaution

- This product complies with the EMC Directives (89/336/EEC, 92/31/EEC) and CE Marking Directive (93/68/EEC).

- This product does not work correctly in the areas other than Europe.
- Pay close attention to all warnings in this manual and keep this manual handy for future reference.
- Should this product fail to operate properly, contact your dealer or the nearest authorised Pioneer service facility.

CAUTION

This product contains a laser diode of higher class than 1. To ensure continued safety, do not remove any covers or attempt to gain access to the inside of the product.

Refer all servicing to qualified personnel.

The following caution label appears on your unit.

Location: on the bottom of the unit



En

On the top of the unit.

CAUTION	. VISIBLE AND INVISIBLE LASER RADIATION WHEN OPEN. . AVOID EXPOSURE TO BEAM.
VORSICHT	. SICHTBARE UND UNSICHTBARE LASERSTRAHLUNG, WENN ABDECKUNG GEÖFFNET NICHT DEM STRAHL AUSSETZEN!
ADVARSEL	. SYNLIG OG OSYNLIG LASERSTRÅLING VED ÅBNING . UNDGA UDSÆTTELSE FOR STRÅLING.
WARNING	. SYNLIG OCH OSYNLIG LASERSTRÅLNING NÄR DENNA DEL ÄR ÖPPNAD BETRÄKTA EJ STRÅLEN.
VARO!	. AVATTAESSA ALTIKUT NÄKYVÄ JA NÄKYMÄTTÖMÄLLE LASERSATEIL YLLE. ÄLÄ KATSO SÄTEESEN.

VRW1699

- The Pioneer CarStereo-Pass is for use only in Germany.
- Always keep the volume low enough for outside sounds to be audible.
- Protect this product from moisture.

Handbrake interlock

Certain functions offered by this Navigation System could be dangerous if used while driving. To prevent them being used while in motion, there is an interlock with your vehicle's handbrake. If you attempt to use these functions while driving, the message "You cannot use this function while driving" will be displayed. Find a safe place to stop and apply the handbrake.

Colour difference of the map display between day and night

To prevent the normal display from appearing too bright and distracting you when driving after dark or in dull conditions, the map background changes automatically to a darker colour when you switch on your vehicle lights. You can, however, turn off this automatic switching (see “Map Display” on page 88).



Daytime display



Night display

The examples in this manual are illustrated using the daytime display. When driving at night, the colours you see may differ from those shown.

To use this function, the Orange/white lead to this unit must be connected correctly.

Avoiding low battery

When using this unit, make sure to start your engine first. Using this unit without starting the engine will run down the battery.

About this disc

For using this unit, use only the disc specified by Pioneer. You cannot use other discs.

■ About the main unit battery

The main unit of your Navigation System has a lithium battery for memory backup. Please dispose of the battery properly by following the instructions below.

WARNING

- Keep the lithium battery out of the reach of the children. Should the battery be swallowed, immediately consult a doctor.

CAUTION

- Do not recharge, disassemble, heat or dispose of the battery in a fire.
- Use a CR2450 (3V) lithium battery only. Never use other types of battery with this unit.
- Do not handle the battery with metallic tools.
- Do not store the lithium battery with metallic materials.
- When disposing of used batteries, please comply with governmental regulations or environmental public institution's rules that apply in your country/area.
- Always check carefully that you are loading the battery with its (+) and (-) poles facing in the proper directions.

How to remove the battery

PRECAUTION:

- Remove the battery from the main unit using a non-metallic tapered instrument.

- 1 Using a screwdriver, remove the screw at the side of the main unit.
- 2 Using a pointed tool, pull out the tray on which the battery is set, and remove the battery.

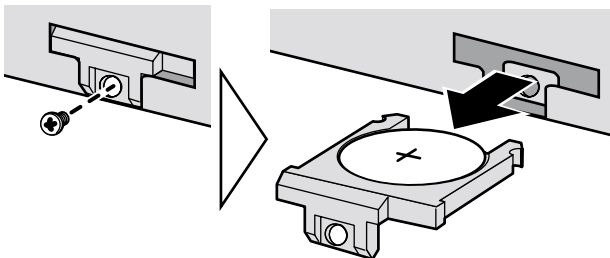

How to Read This Manual

This manual provides all the information you need to make full use of your new Navigation System. The first few sections give an overview of the system and explain how to prepare it for use. The remainder is in the form of a function reference giving full details of every feature. A comprehensive list of all sections of the manual is provided in the table of contents at the beginning of this introduction.

■ How to use this manual

For reasons of safety, it is particularly important that you fully understand your Navigation System before using it. However, you don't have to read the whole manual before obtaining guidance to your first destination. The following summary indicates which chapters you should read now and which you can come back to later.

Read the chapters marked * before attempting to obtain guidance to your first destination.

1. Getting Started*

This chapter introduces the components of your Navigation System and takes you through the initial setup process. You should read this chapter first.

2. Basic Operation*

Read this chapter after going through the setup process. It explains what you see on the display and how to use the menus. You will then be ready to navigate to your first destination.

3. Setting a Route to Your Destination*

This chapter describes a number of ways to choose a destination. Choose the one that suits your first destination and read that section; you can then come back and read the rest of the chapter later.

4. Guidance to Your Destination*

Before actually setting out toward your chosen destination, read this chapter to learn how to interpret the guidance given by your Navigation System.

5. Utilising Various Information

This chapter provides information about the various information available. Read it to learn more about the useful features available to you.

6. Customising Your Navigation System

The behaviour of your Navigation System depends on a number of settings. If you need to change any of the initial settings (default settings), read the relevant section of this chapter.

7. Operating Your Navigation System with Voice

This chapter gives details of the voice recognition capabilities of your Navigation System. Read it when you are ready to begin giving voice commands while under guidance.

Appendix

Read the appendix to learn more about your Navigation System, the technology it uses, and such information as the availability of after-care. Please see "Display Information" in the end of this manual for checking the details of each item on the menu.

■ Terminology

Before moving on, take a few minutes to read the following information about the conventions used in this manual. Familiarity with these conventions will help you greatly as you learn how to use your new equipment.

- Buttons on your Remote Controller are referred to as: NAVI button, MENU button.
- Items in various menus are referred to like this: "New Destination" and "Settings".
- Extra information, alternative use and other notes are presented like this:

☞ After removing the disc from the slot, keep it in the case.

Getting Started

Setup 1: Getting Ready for the Remote Controller

You generally use the Remote Controller to operate the Navigation System. Before using the Remote Controller, set the dipswitches and insert the batteries as described in the following sections.

■ Selecting dipswitches

When you remove the battery cover of the Remote Controller, you will see the dipswitches as shown in the following illustration. You can set each dipswitch using the tip of a ballpoint pen.

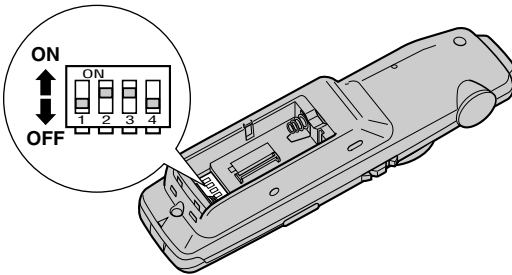

Setting Switch 1

Set Switch 1 depending on the display used.

ON : This is set if turning this on is recommended for a display used with this unit.

OFF : When the following Pioneer displays are used for navigation display:
AVX-P7000CD, AVX-7000, AVD-W8000, AVD-W6000, AVD-W6010,
AVX-7300, AVX-P7300DVD

Setting Switch 3

Set Switch 3 depending on the audio equipment used:

ON : When combining with Pioneer AV master unit (AVM-P9000R, AVM-P8000R)

OFF : When combining with Pioneer Head Unit with IP-BUS
When combining with AVM-P7000R

- ⌋ Switches 2 and 4 are not to be used (It does not matter whether it is ON or OFF).
- ⌋ Please set the switches correctly according to the combination of your equipment. Please make sure that the setting is correct, otherwise the Navigation System will not work properly.

■ **Inserting the batteries to the Remote Controller**

Remove the battery cover, and insert two alkaline (UM-4, AAA, LR03, 1.5V) batteries.

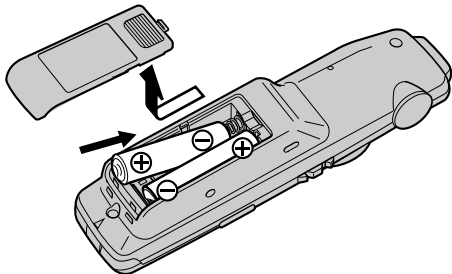

Caution

- Take care to insert the batteries the right way round as shown by the + and - marks in the diagram.
 - Do not mix new batteries with old.
 - Do not mix different types of batteries. Even batteries of the same size may have different voltages.
 - If the Remote Controller will be out of use for a long period, remove the batteries.
 - If a battery leaks, completely clean any liquid or deposits from the battery compartment before inserting new batteries.
 - The supplied batteries cannot be recharged.
 - We recommend using alkaline batteries as replacements.
 - When disposing of used batteries, please comply with governmental regulations or environmental public institutional rules that apply in your country/area.
-

Setup 2: Getting to Know the Components and What They Do

Before using this unit, get to know the name of each component and how it is used.

■ The Remote Controller

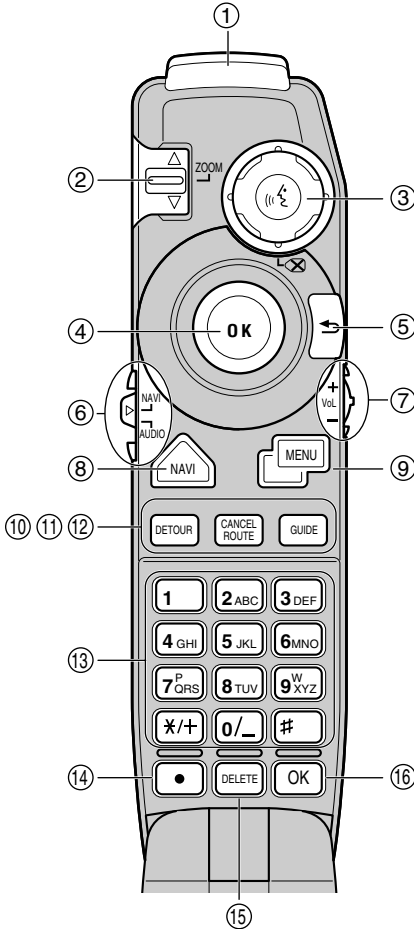

(1) Transmitter

Signals of the Remote Controller are transmitted from here.

(2) Scale controller

You use the scale controller to enlarge or reduce the displayed map. When you move the scale controller downwards, the scale of the displayed map is enlarged and a more detailed map is displayed. Conversely, moving it upwards reduces the displayed map, and a wider area is displayed. Also, when a list is longer than one screen, this controller is used for indicating the next screen or previous screen.

(3) TALK button

You use the TALK button to start voice recognition, allowing you to command the Navigation System by speech. When a voice command is given, you can cycle through possible matches by clicking down this button.

➤ With the "CD-SR80" Steering Remote Controller (sold separately), you can press the BAND button and the F button to switch on the operation mode of the Steering Remote Controller. When the operation mode is switched on, by pressing the BAND button of the Steering Remote Controller, you can activate voice operation, which is equivalent of pressing the TALK button.

(4) Joystick/OK button

Use the joystick to select items in the display and to scroll the map. The joystick is also the OK button; simply press it to select a location on the map or an option displayed on the screen.

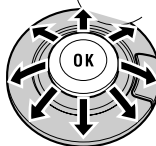

Used as the joystick :

Directions of movements indicated by arrows are possible.

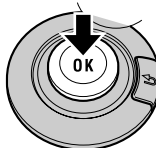

Used as the OK button :

Press straight down.

(5) BACK button

While using a menu, pressing this button cancels the present operation and returns you to the previously displayed menu or list.

(6) Mode switch

Use this switch to select whether the Remote controls the Navigation System or Pioneer's Head Unit. When switching the operation mode, functions of the VOL dial will change.

(7) VOL dial

When you turn the dial downwards, the volume decreases. Turning it upwards increases the volume.

- When the selection switch is set to "NAVI", the volume of the voice guidance for navigation is adjusted.
- When the selection switch is set to "AUDIO", the volume for Pioneer's Head Unit is adjusted. If the dial is pressed, the volume is reduced to around 1/10th of the volume (ATT function). When pressed again, the volume returns to its previous level.

(8) NAVI button

You press the NAVI button to view the map or return to guidance. Also, when the map is scrolled, pressing this button returns to the display of the map of your surroundings.

(9) MENU button

Pressing the MENU button displays a menu of options.

(10) DETOUR button

Press this button to restart route calculation, such as calculating a detour. If this button is pressed for more than two seconds, you can see the information (passing roads and driving distance, and so on) of the route down which you are currently being guided (see Chapter 4 "Guidance to Your Destination").

(11) CANCEL ROUTE button

Press this button to cancel the route guidance. When pressed for more than two seconds, the next via point is recognised as already being passed, and a new route calculation starts (see Chapter 4 "Guidance to Your Destination").

(12) GUIDE button

Press this button if you did not hear the voice guidance properly. If this button is pressed for more than two seconds, you can listen to traffic information (where available.).

(13) Numeric keypad

You use this pad for entering characters or numbers.

(14)

Not used.

(15) DELETE button

Press to delete the character you just entered. If you press this button for more than two seconds, all the characters entered will be deleted.

(16) OK button for numeric keypad

This works in the same way as "OK" on the text palette.

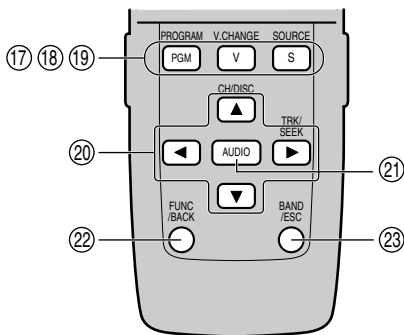

- (17) **PROGRAM** button
(for audio operation)
- (18) **V.CHANGE** button
(for audio operation)
- (19) **SOURCE** button (for audio operation)
- (20) **Cross Key / ▲, ▼, ◀, ▶** button
(for audio operation)
- (21) **AUDIO** button (for audio operation)
- (22) **FUNC/BACK** button
(for audio operation)
- (23) **BAND/ESC** button
(for audio operation)

➤ Each button from (17) to (23) has the same function as the ones for Pioneer's Head Unit, and so you can operate the Head Unit using the Remote Controller. However, some buttons become invalid depending on the combination of the models.

■ Microphone

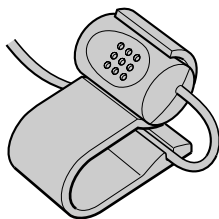

(1) Microphone

After pressing the TALK button to start voice operation, this microphone hears your commands.

■ Main unit

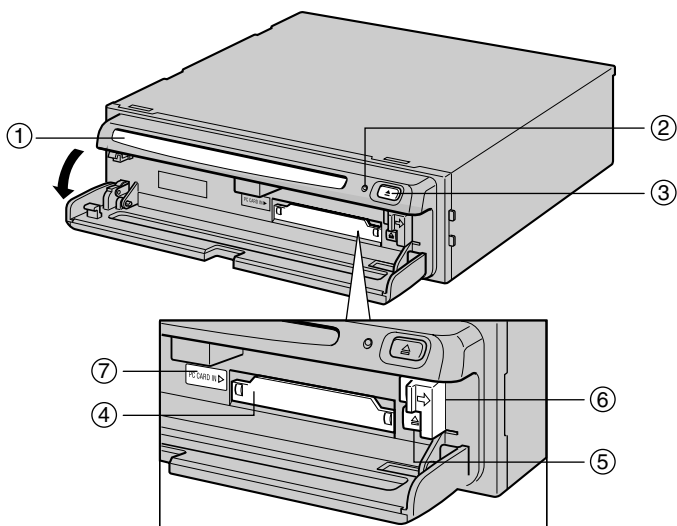

(1) Disc loading slot

(2) Reset button

If the system goes wrong, reset it by pressing this recessed button with a ballpoint pen or similar pointed object. (See “Resetting the System” on page 102).

(3) Disc ejection button

(4) PC card slot

(5) PC card ejection button

Remove the PC card by pressing this button.

(6) PC card lock lever

This lever is used when you remove the PC card.

(7) PC card lock lamp

The red light goes on when the PC card is inserted and a proper connection is made.

Setting and removing the disc

Insert the disc to the disc slot with the label-side up. To remove the disc, press the disc ejection button on the right-hand side of the disc loading slot.

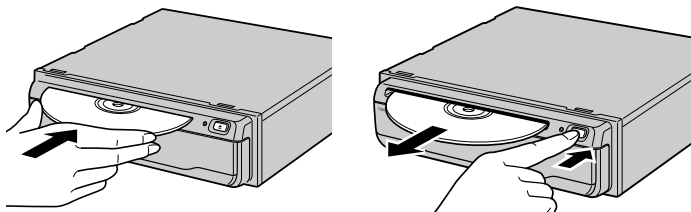

- ⌚ Do not try to use discs other than a disc designed for this system. Please use only the disc specified by Pioneer.
- ⌚ Do not attempt to use discs that is cracked, scratched, bent, or otherwise damaged.
- ⌚ Treat your disc carefully. See “Handling and Care of the Disc” on page 101 for advice on proper handling and use.
- ⌚ After removing the disc from the slot, keep it in the case.

Setting the PC card

Open the cover at the front of the main unit. Hold the PC card label-side up: the arrow shows the direction of insertion. Insert the card firmly until the PC card ejection button pops out. If the main unit power is on, the PC card lock lamp changes from green to red, showing that the PC card is inserted correctly and ready for use.

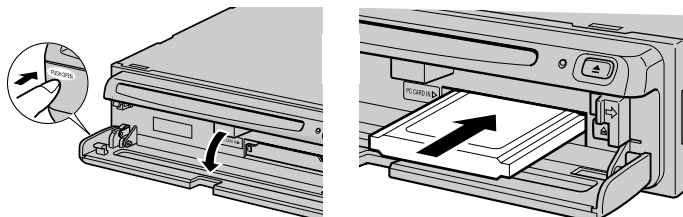

Removing the PC Card

Open the cover on the front of the main unit. Slide the PC card lock lever to the right (1), and hold it there. Check that the PC card lock lamp has changed to green, and then press the PC card ejection button (2). (Keep sliding the PC card lock lever to the right until the PC card is removed completely.)

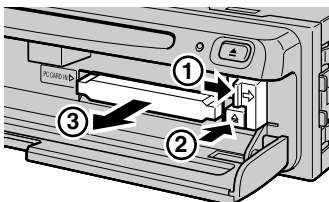

Caution

Do not remove the PC card while the PC card lock lamp is red. It may break the main unit of the Navigation System or the PC card.

- ⌚ PC card can be set or removed regardless of the power ON/OFF of the main unit (ON/OFF of the engine).
- ⌚ You can only use a card that conforms to the PCMCIA Type II (5V) standard. If you attempt to use a card complying with a different standard, the card slot may be damaged, or a malfunction may occur.
- ⌚ Do not remove the card while editing the data on the PC card. You may break the main unit of the navigation system, or corrupt the data stored on the PC card.

Setup 3: Installing the Program

The program is installed to the main unit of the Navigation System using the disc provided. When installing the program, you carry out the following operations. When all the setup procedures are completed, the map of your surroundings appears, and you can use the Navigation System.

1. Insert the disc while the vehicle is parked.
↓
2. Select the language used for the Navigation System.
↓
3. Setting the clock.

1 Park your vehicle in a safe place.

Leave the engine on, and make sure that the handbrake is on.

2 Insert the disc to the main unit of the Navigation System.

3 Select “Yes” and click the OK button.

When you start this unit for the first time, the message confirming if you select another language.

English is the default language of the Navigation System. If desired, you can select another language.

⤷ To keep English, move the joystick down to highlight “No”, and click the OK button. After this, proceed to Step 6.

⤷ When you want to select another language, highlight “Yes”, click the OK button, and proceed to the next step.

4 Select the language from the list.

The list of the languages you can use appears. Move the joystick up or down to highlight the language you want.



5 Click the OK button.

Installation of the program, in the language you chose, begins. During the installation, the following display appears to show the progress.

When the installation is complete, the opening display appears.

Caution

Once the installation of the program starts, do not stop the engine of your vehicle until the installation is completed.

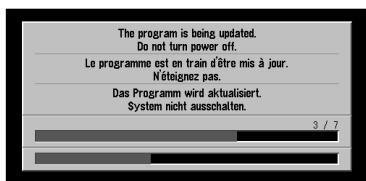

6 Check the details of the cautionary message and click the OK button.

You can also proceed to the next step by pressing the TALK button.

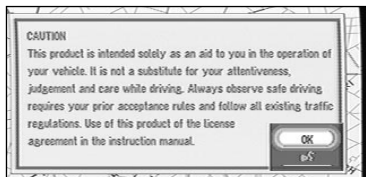

A message asking to set the clock appears.

7 Click the OK button.

The clock setting display appears.

8 Set the clock.

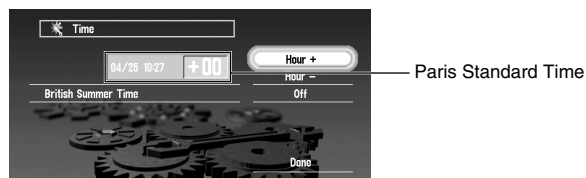

The time difference between the time originally set in this unit (Paris Standard Time) and the current location of your vehicle is shown. If necessary, adjust the time difference. Move the joystick to select “Hour +” or “Hour -” and click the OK button to change the time difference by one hour. Set the time difference between the current location of your vehicle and the Paris Standard Time.



9 If necessary, set to summer time.

Summer time is on by default. “Off” is shown on the right-hand side of “British Summer Time”.

If summer time is in effect, move the joystick to select “Off” and click the OK button. When the list of selectable options (“On” and “Off”) appears, move the joystick to select “On” and click the OK button. The summer time setting is then turned On.



10 Select “Done” and click the OK button.



The map of your surroundings appears.

This completes the setup of your Navigation System. Chapter 2 explains the basic operation of your Navigation System.

➤ To change the language and time later, see Chapter 6 “Customising Your Navigation System”.

Basic Operation

Switching On and Off

Switching On

When the engine of your vehicle is running, the power of the main unit of your Navigation System is turned on. After the opening screen appears for a few seconds, a cautionary message appears. Read this message and click the OK or the TALK button; the map of your surroundings appears, and you can now use the Navigation System.

- ☞ If the disc is not set, the message asking to insert the disc appears. After you set the disc correctly, your Navigation System starts up.

When the password is set

After your Navigation System starts and the cautionary message appears, you are asked to enter the password. Enter your password and select “OK”, and click the OK button. (You cannot enter your password using numeric keypad of the Remote Controller.) The map of your surroundings appears, and you can use your Navigation System.

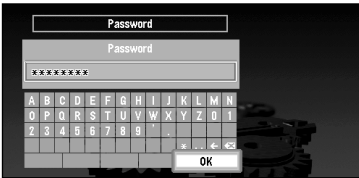

- ☞ For the details of setting the password, see “Registering a Password” on page 71.

Switching Off

When you turn your vehicle’s engine off, your Navigation System is also switched off.

- ☞ If you have not arrived at the vicinity of your destination, the route set will not be deleted even if you turn the power to your Navigation System off.

Types of Menu

You perform most tasks through using menus. A typical sequence of steps is as follows: “Select a menu, Select a menu item with the joystick, and Click the OK button”. There are two types of menu: the “Main menu” and the “Shortcut menu”.

■ Main menu

With the map displayed, press the MENU button and the Main menu appears. You use this menu for basic operation of your Navigation System.

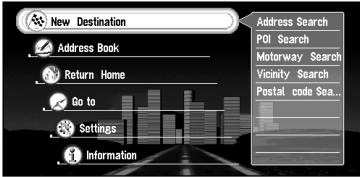

New Destination

The destination is searched and the route to this destination is set (see “Finding a destination on the map” on page 39).

Address Book

Past destinations, via points, and the list of the registered locations are shown. If you select your destination from this menu, your route is calculated (see Chapters 3 and 5).

Return Home

Set your home as your destination and your route is calculated (see Chapter 3).

Go to ...

Set your favourite location, such as your workplace, as your destination and your route is calculated (see Chapter 3).

Settings

Customise the functions of your Navigation System for your own selections (see Chapters 5 and 6). When using PC card, you use this menu (see Chapter 5).

Information

To get information, such as traffic information along the route, you are travelling (where available), or the condition of the navigation, you use this menu (see Chapter 5).

■ Shortcut menu

While the map is shown, click the OK button to show the Shortcut menu. You can do various tasks, such as route calculation for the location pointed by cross pointer, or registering a location in the Address Book, faster than using the normal menu.

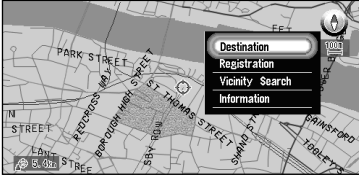

Destination

You select the destination with cross pointer and the route is set (see “Finding a destination on the map” on page 39). When your destination or via point is set with this method, some information on the streets around the cross pointer (or the area of the house number) or POI is picked up.

Registration

Registering the location pointed by cross pointer to Address Book (see Chapter 5).

Vicinity Search

You select a location with cross pointer and POIs (Points Of Interest) nearby are found (see Chapter 3).

Information

You select a location with cross pointer and information about the location appears. (See “Viewing the information of the mark displayed on the map” on page 38.)

- Items that are coloured grey cannot be selected: items are greyed depending on the previous operation.

Basic Navigation

This section describes basic navigation, such as how to select menu items, using setting your destination as an example. There are several methods of setting the destination but, in this example, route calculation by specifying address (Address Search) is explained.

Caution

For safety reasons, you cannot use these functions while your vehicle is in motion. Stop and put the handbrake on before use.

1 Indicate Main menu.

With the map displayed, press the MENU button.

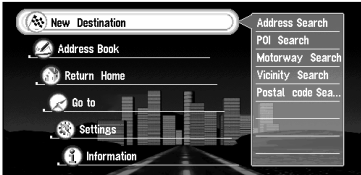

The Main menu appears. Only “New Destination” is highlighted, and it has different colour from the other items. This shows that this item is being selected. On the right-hand side of the display, a small list appears. This shows that the item currently being selected is further divided into sub-menus.

2 Select the items you want.

Move the joystick up or down. As you move the joystick, the item being highlighted also changes. When the item you want is highlighted, click the OK button.

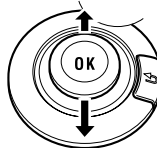
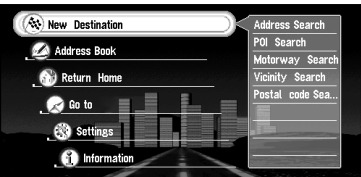

In this example, you want to find your destination, so highlight “New Destination” and click the OK button. The menu (submenu) of the items included in “New Destination” appears.

3 Select the method of searching your destination.

Select “Address Search” and click the OK button.

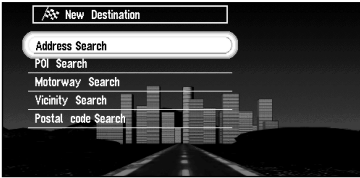

4 Select the country where your destination is located.

When the destination is in another country, select “Country” and click the OK button.

When the list of countries appears, select the desired country and click the OK button.

(When searching the destination next time, the Navigation System searches the destination from the data of the country selected here.) For the details of the method of selecting “Country”, see “Selecting the country where you want to search” on page 42.



5 Search the city where your destination is located.

Enter the name of the city using the text palette. To enter the name, you select each character with the joystick and click the OK button.

For example, enter the name of a city where, or near where, you live. If you enter the first few letters, a list of matching place names appears automatically.

- ☞ If a list does not appear, check your spelling and correct as necessary. Enter the name of the city in full and select “OK” on the bottom-right of the display. Click the OK button. If there are no matching cities, try the name of the different city nearby.

How to use text palette

Move the joystick up or down, or left or right, to highlight a letter you want to enter. If you click the OK button, the selected letter appears in the text box. As you enter an one letter, your Navigation System narrows down the possible cities, and the items in the list that appears on the right-hand side of the display change accordingly. Also, any letters you cannot enter (because they do not feature in a known place name) are shown in grey, to help you select and enter the letters faster.



(1) Text box

The letters entered appear here.

(2) Text palette

Letters of the alphabet. Letters you cannot enter are greyed out.

(3) Space ()

You can enter a space.

(4) Delete backward (←)

Deletes the previous character.

(5) All delete (⊗)

All the letters entered are deleted. When the DELETE button of the Remote Control is pressed for more than two seconds, all the letters entered can be deleted as well.

(6) Function button

If you highlight this button, the functions assigned to each button appear in a popup display.

(7) Number of matching candidates

(8) Matching candidates

Items displayed here cannot be selected.

(9) OK

If you select and click the OK button, matching candidates and the time are all displayed in a list.

- ↳ When you go back to the previous display by pressing the BACK button, you may not be able to enter letters. In such a case, delete the letters entered in the text box.

Entering letters using numeric keypad of the Remote Controller

Every time you press the key, the letters assigned to the key are displayed in sequence. If you press different keys while the letter to enter is selected, or if you press the OK button on the bottom-right of the numeric keypad, the selected letter appears in the text box.

6 Select the city name of your destination from the list and click the OK button.

Move the joystick to select the item of your destination from the list. If the location shown in the list can be identified, the map of the location appears on the right-hand side of the list so that you can roughly check the location.



When the list of the items goes over several screens

If the list of the matching city names cannot be displayed within one screen, a scrollbar appears on the left-hand side of the list to show that there are more items. If you move the joystick up or down, the remaining items appear. (If there are many items, you can move the list faster by moving the scale controller up and down.)

If an arrow appears at the left-hand side of the item

If you click the joystick to the left, the map of the location you selected from the list appears. Here, the information of the selected location is displayed by letters at the bottom of the screen. If you click the OK button with this display, the Shortcut menu appears (see "Shortcut menu" on page 27), and you can select the location displayed as your destination, or look at the detailed information.

7 Select the street name where your destination is located.

You select the street name in the same way as for a city name. When the number of matching streets is narrowed down, the list of the matching streets automatically appears. (If the all letters you want to enter are coloured grey and you cannot enter, select "OK" and click the OK button to show the list.)



8 Select the street from the list and click the OK button.



If the selected street goes across several cities

For example, if the selected street goes across three cities, the list of these cities appears when you click the OK button. Select the location for your destination from the list, click the OK button to proceed to the next step.

9 Specify the house number.

You select the house numbers in the same way as for a city name. When the input is completed, select “OK” and click the OK button.



10 If you can enter a house number, select the house number from the list, and click the OK button.

Once the location is decided, your Navigation System starts to calculate a route with that location as your destination.



When the route is calculated, the map of your surroundings appears. The street from your current location to your destination turns to green, and the route being set is shown.

When you cannot enter the house number

From the function button at the bottom of the screen, select a method of search and click the OK button.

On this display, you can select the following items:

- Quick Route Cal (Calculation) :** The route is calculated with the well-known point (mostly, it is the middle point of the street selected previously) as your destination.
- Cross Street :** You enter the name of the second street and search for the surrounding area of its intersection with the first street. It is convenient when there is no house number for your destination, or when you cannot enter the house number of the selected street (See “Specifying an Intersection as Your Destination” on page 48.)
- View Map :** You can view a map of the location matching to the house number entered. If there is no complete match with the entered house number, you can also display the map of the well-known point on the street, then scroll the map to show the Shortcut menu (see “Shortcut menu” on page 27), then to set the location as your destination.

- If you want to delete the route being set, press the CANCEL ROUTE button. When the message confirming the deletion appears, select “Yes (all)”. Click the OK button to delete the route.
- If you want to return to the map of your surroundings, press the NAVI button.
- Once searched for, a location is automatically stored in the “Address Book” (see “Editing the Address Book” on page 63).

How to Use the Map

Most of the information provided by your Navigation System can be seen on the map. You need to get to know how the information appears on the map.

How to view the map of the current location

The display is like a conventional map, and shows roads of various designations as well as geographical features such as rivers, parks, and forests.

While the menu is displayed, you can switch to the map of your surroundings, by pressing the NAVI button.

When the route is not yet set, map mode is always displayed, but during the route guidance, you can switch between “Map mode”, “Driver’s view”, “Arrow mode”, and “Side arrow mode” by clicking the OK button.

Caution

In Driver’s view, the speed meter is indicated on the screen, but this will differ from the actual speed of your vehicle. Use the speed meter of your vehicle for confirming the speed.

Map mode

The map of your surroundings is shown. Unless the route is set, this mode is always shown.

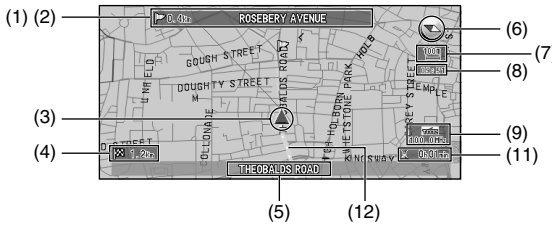

Driver’s view

The map from the driver’s viewpoint is shown.

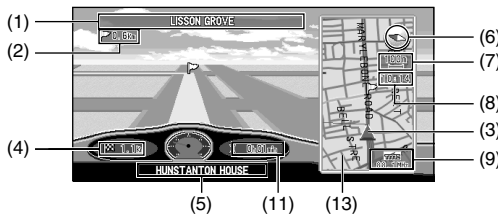

Arrow mode

The direction of travel is shown by a simple arrow. When approaching a guidance point, such as an intersection, the display switches to show the distance and direction to the guidance point.

Normal condition

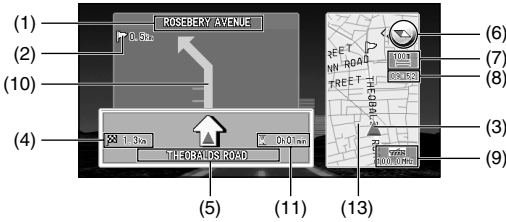

When approaching an intersection

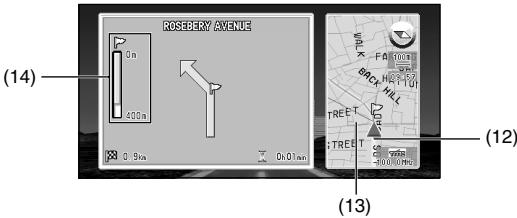

Side arrow mode

The map of your surroundings is shown on the left, and an arrow showing the direction of travel is shown on the right.

Normal condition

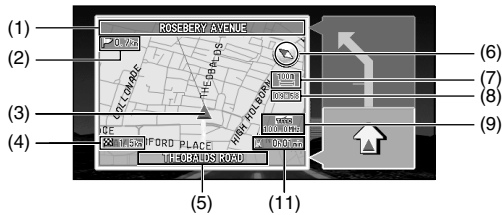

When approaching an intersection

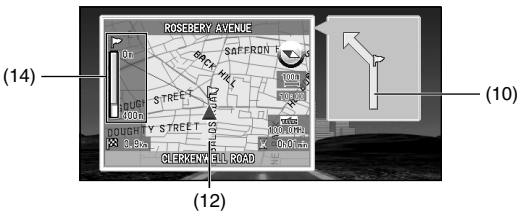

Guidance point*

The next turning point is shown by a yellow flag.

Destination*

The checker-flag indicates your destination

(1) Name of the street you drive next.*

(2) Distance to the guidance point*

(3) Current location

The current location of your vehicle. The arrow shows your heading, and the display moves automatically as you drive.

(4) Distance to the destination*

(5) Name of the street you are in

(6) Compass

The red arrow shows North.

(7) Map scale indicator

The figure gives the distance represented by the red bar. In Arrow mode and Driver's view, it shows the scale of the map displayed on the right-hand side of the screen.

(8) Current time

(9) TMC mark and the name of the broadcasting station

The name of RDS broadcasting station this unit is receiving is shown (where available).

(10) Travelling direction*

(11) Estimated time of arrival (or travel time to your destination)*

(12) Tracking mark

The tracking mark shows the route your vehicle has travelled.

(13) Map of your surroundings*

(14) Distance to an intersection*

It is displayed in Arrow mode and Side arrow mode. The green bar gets shorter as your vehicle approaches an intersection.

- Information with the mark (*) appears only when the route is set.
- You can display the current time and estimated time of arrival (or travel time to your destination) on the screen. For the details of setting, see "Travel Time Display" on page 89.
- You can select the method of deleting tracking mark. For the details, see "Tracking Display" on page 88.
- When "Zoom Map of Intersection" (see "Zoom Map of Intersection" on page 87) is set "ON", an enlarged map showing the area around an intersection appears as you approach the intersection (except Driver's view).
- Tracking display shows about 200 km tracking of your vehicle with a white dots. When your vehicle speed is under 5 km/h (3mile/h), the dots is red. When your vehicle speed is more than 5 km/h(3mile/h), but less than 20 km/h (12mile/h), tracking shows in orange dots.

■ Changing the scale of the map

On the top-right of the map display, the scale of the map is shown. If you move the scale controller up or down, you can change the scale of the map through 16 levels:

25m, 50m, 100m, 200m, 500m, 1km, 2km, 5km, 10km, 20km, 50km, 100km, 200km, 500km, 1000km, 2000km (25yd, 50yd, 100yd, 1/4mi, 1/2mi, 3/4mi, 1mi, 2 1/2mi, 5mi, 10mi, 25mi, 50mi, 100mi, 250mi, 500mi, 1000mi). If you keep holding up or down the scale controller, you can zoom in or out in smaller increments.



When you want to see smaller streets with a more detailed map

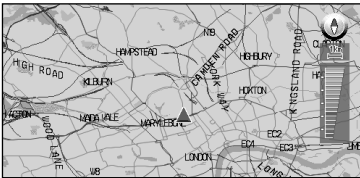

When you want to know a rough position, or seeing wider range

■ Moving the map to the location you want to see

You can move the joystick of the Remote Controller up and down, left and right, or diagonally. If you move the joystick towards the location you want to see, the map moves accordingly. If you press down the joystick while moving the map, you can move the map more quickly. At this time, the cross pointer appears at the centre of the screen. Also a line connecting between the current location and cross pointer appears.



(1) Scroll location

The position of cross pointer shows the location selected on the current map.

(2) Distance from the current location

The distance between the location pointed by cross pointer and the current location is shown.

Viewing the information of the mark displayed on the map

You can check the information such as address, about the mark (POI, your home, your favourite location, or an icon of TMC traffic information) specified by the cross pointer.

- 1 **Place the cross pointer on the mark shown on the map, and click the OK button.**
The Shortcut menu appears.
- 2 **Select “Information” and click the OK button.**

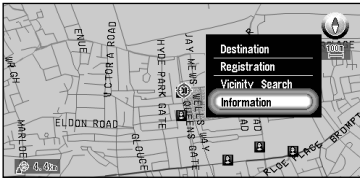

Information about the specified mark appears. The type of information shown varies according to the mark. If there is another mark near the mark selected you may turn the scale controller up or down, to display the information for another mark. (Information may not be shown for some marks.)

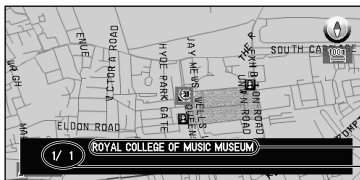

Information of the mark
Number of information you can check

Types of information :

Name of the registered location (Include home and specific location)

Information of the Points Of Interest (POI) displayed on the map (see “Displaying Certain Points Of Interest on the Map” on page 62)

RDS-TMC traffic information (see “Using Traffic Information” on page 74)

- 3 **Click the OK button.**

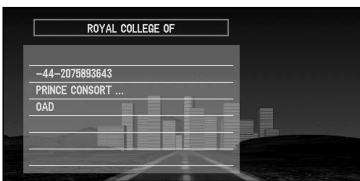

More detailed information appears.

- 4 **Press the NAVI button.**
You are returned to the map of your surroundings.

Finding a destination on the map

When you select “Map search” as the search method, or when you select “Destination” in the Shortcut menu, you can specify your destination on the map.

1 Select “Map Search” from the list and click the OK button.

The map display appears.

☞ You can also press the NAVI button to show the map.

2 Place the cross pointer on the place you want to set as your destination. Then click the OK button.

Some information on the streets around the cross pointer (or the area of the house number) is picked up, then information about the specified place appears on the display.

☞ If you display the Shortcut menu, select “Destination” and click the OK button to proceed to Step 3.

3 Switch between multiple items of information by turning the scale controller up or down.

4 Click the OK button.

Route calculation starts.

When you do not know how to use the Navigation System

When you are new to using the Navigation System, it may take you a little time to work what to do next. After a few seconds of inactivity, a help message may appear, which tells you what you can do on the screen. The message disappears when you move the joystick.

When you are using your Navigation System with voice operation, examples of the commands you can say appear on the screen (see Chapter 7).

When you are used to using the Navigation System, you can opt that the help messages are not provided. For details, see “Help Menu” on page 89.

Setting a Route to Your Destination





Basic Flow of Route Calculation

Based on the information you know about your destination, your Navigation System searches for your destination on the map, and calculates the route.

Caution

For safety reasons, these functions are not available while your vehicle is in motion. Stop and apply the handbrake before use.

Flow of operation (example)

1. Press the MENU button and display the Main menu.
- 
2. Select "New Destination" from the Main menu.
- 
3. Select the method of searching for your destination.
- 
4. Enter the information about your destination.
- 
5. Your Navigation System sets the route to your destination, and the map of your surroundings appears.

- ⤷ If you press the BACK button during route calculation, the calculation is cancelled and the map display appears.
- ⤷ If you search for the location when the route is already set, after the search, a message asking whether to carry out new route calculation using this location as your destination, or as a via point appears. For the details, see "Adding Via Points to the Current Route" on page 59 and "Cancelling the Route Guidance" on page 58.
- ⤷ During the search of your destination, if you click the joystick to the left while the triangle mark is displayed on the left-hand side of the list, you can check the location being selected on the map.
- ⤷ Some information on traffic regulations by days or time is indicated according to the time when the route calculation is performed. Thus, it may not correspond with a certain traffic regulation when your vehicle actually passes the location. Also, the information of the traffic regulations provided will be for a passenger vehicle, and not for a truck/lorry or other delivery vehicles. When driving your vehicle, follow the actual traffic regulations.
- ⤷ For the details of route guidance after your destination is searched and the route is set, see Chapter 4.

- ☞ By using the Settings menu, you can change the conditions for route calculation. For the details, see Chapter 6 “Route No.,” “Fastest/Shortest,” “Avoid Motorway,” “Avoid Ferry,” “Avoid Toll Road” on pages 86 to 87.

■ **Selecting the country where you want to search**

Information on the disc is arranged according to each country. When searching for your destination, your Navigation System searches for it in the country currently selected. Therefore, if your destination is in another country, you must change the country setting before starting the destination search. (Once the country is selected, the Navigation System searches the destination from the data of this country until the setting is altered.)

Here, Address Search is given as an example:

- 1 **From the Main menu, select “New Destination”, and then select “Address Search”.**
- 2 **Select “Country” and click the OK button.**



- 3 **Select the area you want to search, and click the OK button.**

When you are returned to the initial display, proceed to the searching operation.



■ **Perform the route calculation of the several route options, and select one**

By combining several searching conditions, you can get route calculations of six route options to your destination. After route options are calculated, select the one you want.

- 1 **Change the setting of “Route No.” in “Settings” menu.**
For the details of the method of changing the setting, see “Modifying the Default Settings” on page 85 and “Route No.” on page 86.
- 2 **Search your destination and set the route.**
- 3 **Select “Route Select” and click the OK button.**
The next route option appears. Repeat this procedure until the route you want to take appears.

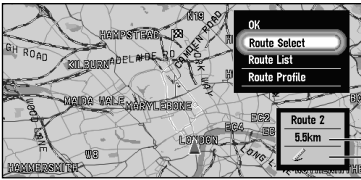

Distance to your destination
Condition of route calculation

On this display, you can select the following items:

Route Profile : You can view the list of the roads you drive through.

Route List : You can view the list of the conditions for route calculation of all the route options and of the distances to your destination.

About the route condition

Shortest : Calculate a route with the fastest distance to your destination as a priority.

Fastest: Calculate a route with the shortest travel time to your destination as a priority.

Alternative route : A route other than the ones calculated by the above two methods is shown.

Avoid motorway : Calculate a route that avoids motorway.

When two conditions is mixed as “Shortest” & “Avoid Motorway”, the quickest route to your destination while avoiding a motorway is shown.

Route Profile

Name of the streets
you drive through

Route Profile	
WHITEHALL	88m
CHARING CROSS	96m
COCKSPUR STREET	118m
TRAFALGAR SQUARE	71m
PALL MALL EAST	38m
TRAFALGAR SQUARE	156m
ST MARTINS PLACE	81m

Driving distance

Route List

Distance to
your destination

Route List			Route Condition
Route 1	8.0km	🔄	Fastest
Route 2	8.0km	🚧	Shortest
Route 3	8.0km	🚧	Alternative Route
Route 4	8.0km	🚧	Avoid Motorway
Route 5	8.0km	🚧	
Route 6	8.0km	🚧	

Conditions of
route calculation

🔙 To return to the initial display from the “Route Profile” display or the “Route List” display, press the BACK button.

4 Select “OK” and click the OK button.

The route you selected is accepted, and the map of your surroundings appears. When you start driving, the route guidance begins.

🔙 If the above operations are not done within 30 seconds after the route calculation is completed and you have started your vehicle, the first route is automatically chosen.

- It may take some time until a route profile is shown after a route calculation. In addition, when a long distance route is calculated, your Navigation System may not be able to list all the roads. (In this case, the remaining roads will be shown in the list as you drive on.)

Route Calculation to Your Home Location or to Your Favourite Location

If your home location is registered, the route home can be calculated, by a single press of the button from the Main menu. Also, you can register one location, such as your workplace, as your favourite location, and the route is calculated in a similar way.

- 1 Select “Return Home” or “<favourite location name>” from the Main menu, and click the OK button.

Route calculation starts.

- ☞ For the details of the method of registering the location, see “Registering Your Home and Your Favourite Location” on page 68. Also, you can change the registered information later.
- ☞ When your favourite location is not registered, “Go to ...” is displayed on menu. Once you register the location, it changes to “<favourite location name>.”

Selecting your Destination from the Address Book

Destinations and via points you have searched before or registered locations are stored in the “Address Book”. By simply selecting your destination from the Address Book menu, route calculation to the location can be done quickly.

- 1 Select “Address Book” on the Main menu, and click the OK button.

The Address Book menu appears.

- 2 Select your destination and click the OK button.

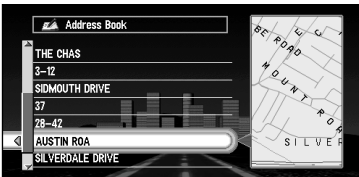

Route calculation starts.

- ☞ You can edit information, such as names, about the locations stored in Address Book, or delete them. For details, see “Editing the Address Book” on page 63.

Searching for your Destination by Address

You can specify the address of your destination. The route to a specific intersection or street, or for the central part of the city, can be also calculated. (For the details of the operation, see “Basic Operation” on page 25.)

- 1 From the Main menu, select “New Destination” and then select “Address Search”. Click the OK button.
- 2 Enter the city name.



You can select the following items:

Nationwide : Select when you do not know the city names of your destination. Proceed to the step, “Having selected “Nationwide” on the display of entering city name” explained below.

City History : You can view the list of the cities you have searched in the past.

Nearby City : You can view the list of the cities near the current location.

➤ If necessary, change the country setting. For the details, see “Selecting the country where you want to search” on page 42.

- 3 Select the city you want from the list, and click the OK button.
- 4 Enter the street name.

For example, for “West Higgins Road”, you can just enter the part of the name, such as “Higgins”.



You can select the following item:

City Centre : The central part of the city selected becomes your destination when starting route calculation. If there are several matching locations, the list of those locations appears. Select the location you want to set as your destination, and click the OK button to start the route calculation.

- 5 Select the street from the list and click the OK button.

If there are several streets with the same name, the list of areas that the specified streets go through may appear. In this case, select the area where your destination is located, and click the OK button to proceed to the next step.

6 Enter house number and select “OK”.

If you enter the house number and click the OK button, route calculation starts. If there are several locations corresponding to the entered house number, or there is no house number in that location, a list of house number range appears. In this case, select the range you want to set as your destination, and click the OK button to start the route calculation.



On this display, you can select the following items:

Quick Route Cal (Calculation) : The route is calculated with the well-known point (mostly, it is the middle point of the street selected previously) as your destination.

Cross Street : You enter the name of the second street and search for the surrounding area of its intersection with the first street. It is convenient when there is no house number for your destination, or when you cannot enter the house number of the selected street (See “Specifying an Intersection as Your Destination” explained below.)

View Map : You can view a map of the location matching to the house number entered. If there is no complete match with the entered house number, you can also display the map of the well-known point on the street, then scroll the map to show the Shortcut menu (see “Shortcut menu” on page 27), then to set the location as your destination.

7 Click the OK button.

Route calculation starts.

Having selected “Nationwide” on the display of entering city name

Based on the information of streets and house numbers, the range of your destination is narrowed.

- If there are several streets with the same name, the list of the cities where the streets run is shown.
- If the selected street goes across several cities, the list for selecting the area in which your destination is located is shown.

Specifying an Intersection as Your Destination

By selecting two streets, route calculation for the intersection can be performed. Its basic operation is the same as “Searching for your Destination by Address” explained above.

- 1 Select “New Destination” from the Main menu and then select “Address Search”. Click the OK button.**

The display for entering a city name appears.

↻ If necessary, change the country setting. For details, see “Selecting the country where you want to search” above.

- 2 Enter the city name.**

The list of the cities matching the name entered appears.

- 3 Select the city for your destination, and click the OK button.**

The display for entering the street name appears.

- 4 Enter the first street name, and click the OK button.**

The list of the streets matching the name entered appears.

- 5 Select the street and click the OK button.**

The display for entering house number appears.

- 6 Select “Cross Street” and click the OK button.**

The display for entering the name of the second street appears.

- 7 Enter the second street name.**

The list of the matching streets appears.

- 8 Select the street and click the OK button.**

If there are points where selected streets cross, the list of those points appears.

If there are no intersections in the selected city, the message, asking to select other streets appears. Select “Yes” and click the OK button, and you return to Step 7. (If you select “No”, the search is cancelled.)

- 9 Select the surrounding area of the intersection for your destination, and click the OK button.**

Route calculation starts.

Finding Your Destination by Selecting the Type of Facility

Information about various facilities (Points Of Interest - POI), such as stations, amusement parks or restaurants is available. By selecting the category, you can search for a Point Of Interest.

■ ***Searching for Points of Interest (POI)***

- 1 Select “New Destination” on the Main menu, and then select “POI search”. Click the OK button.**

The display for entering a city name appears.

- ☞ If necessary, change the country setting. For the details, see “Selecting the country where you want to search” on page 42.

- 2 Enter the city name.**

The list of cities appears.

On this display, you can select the following items.

Nationwide : Select when you do not know the city name, or you want to search without specifying the country where the destination is located. Proceed to Step 4.

City History : You can view the list of the cities you have searched in the past.

Nearby City : You can view the list of the cities near the current location.

- 3 Select the city you want from the list, and click the OK button.**

The list of POI categories appears.

- 4 Select the category and click the OK button.**

POI are divided into several categories. Select one and click the OK button to proceed to the next step.

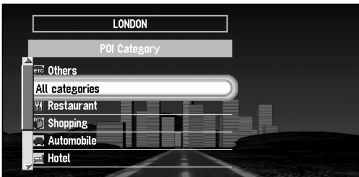

A list of more detailed subcategories appears if you click the OK button.

- ☞ If you do not know which category the POI you want to search is in, select “All Category”.

- ☞ If you select a city in Step 3, only the POI existing in the area is displayed in the list.

- 5 Select the subcategory and click the OK button.**

The display for entering the name of the POI appears.

6 Enter the name of POI and select “OK”. Click the OK button.



➤ If you select “Show All” and click the OK button, the list of all the facilities included in the category you selected appears.

7 Select POI for your destination, and click the OK button.



Route calculation starts if you click the OK button.

➤ If the selected Point Of Interest is a chain store that has many branches, a list of matching POI appears. Select a POI from the list and click the OK button.

■ Finding POI in your surroundings or around the cross pointer

You can search for Points Of Interest in your surroundings or around the cross pointer on the map. Use it to find somewhere to visit during a journey.

1 Select “New Destination” from the Main menu, and then select “Vicinity Search”. Click the OK button.

The list of Points Of Interest categories appears.

2 Select the category and click the OK button.

➤ If you want to search with more detailed categories, move the joystick to the left. The list of subcategories appears. Select the subcategory you want and click the OK button.

3 Select POI and click the OK button.

Names of POI and their distance from your current location appear. They are listed in nearest-to-furthest order.

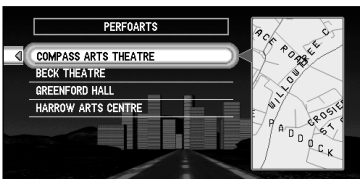

Route calculation starts if you click the OK button.

➤ When the calculation is completed, POI around the specified location are shown on a map.

➤ This function can also be used from the Shortcut menu (see “Shortcut menu” on page 27).

Finding Your Destination by Specifying the Postal Code

If you know the postal code of your destination, you can use it to find your destination.

1 Select “New Destination” from the Main menu, and then select “Postal code Search”. Click the OK button.

- ☞ If necessary, change the country setting. For the details, see “Selecting the country where you want to search” on page 42.

2 Enter the postal code and select “OK”. Then click the OK button.

The list of the postal codes perfectly matching the numbers entered appears.

- ☞ If the postal code you entered is not found, a message appears. Select “Yes” and click the OK button, and re-enter the postal code. (If you select “No”, the search is cancelled.)

3 Select the postal code and click the OK button.

The list of the cities around the area corresponding to the selected postal code appears.

- ☞ If you move the joystick to the left, the map of the area corresponding to the selected postal code appears.

4 Search your destination following the instructions from the Step 3 of “Searching Your Destination by Address” onwards.

- ☞ If a city, which is set as your destination, is located in areas outside the map displayed when selecting a postal code, or so many cities are located near that location, even if the city in the area of the selected postal code, it may not be shown in a list.

- ☞ In the disc, not all the postal codes are recorded. Thus, you may not be able to search the location corresponding to the postal code you enter. In such a case, try the following:

- In the case of the postal code which contains the letters such as “1322HP”, enter only the numbers (in case of Holland).
- For the postal code such as “SL2 4QP”, enter without last letters such as “SL 4” (in case of England).

Setting an Entrance or Exit of a Motorway as Your Destination

You can set the entrance or exit of motorway as your destination.

- 1 Select “New Destination” from the Main menu, and then select “Motorway Search”. Click the OK button.**
The display for entering the name of the motorway appears.
 - If necessary, change the country setting. For the details, see “Selecting the country where you want to search” on page 42.
- 2 Enter the name of motorway and select “OK”. Then click the OK button.**
The list of the motorways matching the name appears.
- 3 Select the motorway and click the OK button.**
The display for selecting your destination to the entrance or to the exit of the motorway appears.
- 4 Choose “Entrance” or “Exit” and click the OK button.**
The list of entrances to, or exits from, the selected motorway appears.
- 5 Select your destination and click the OK button.**
Route calculation starts.

Guidance to Your Destination

Route Guidance by Your Navigation System

After setting the route, once you start your vehicle, route guidance by display and voice begins. When you arrive at your destination, a message indicating the completion of route guidance appears, and the normal map display returns.

■ Route guidance by display and voice

Once the route to your destination is set, the map of your surroundings automatically appears, and route guidance starts. On the map, a bright green line, extending from the symbol that denotes your vehicle, shows the route.

Information guided by voice

Your Navigation System guides the following information with the timing adjusted to the speed of your vehicle:

- Distance to the next turning point
- Travelling direction
- Road number of the motorway
- Via point
- Your destination

☞ If you did not hear the voice guidance properly, press the GUIDE button on the Remote Controller to listen to it again.

Display during the route guidance

There are four types of displays available during the route guidance: “Map mode”, “Driver’s view”, “Arrow mode” and “Side arrow mode”. You can switch the view by clicking the OK button; the display cycles through the modes: “Map mode” → “Driver’s view” → “Arrow mode” → “Side arrow mode” and back to “Map mode”.

☞ For the details of viewing the display, see “How to Use the Map” on page 34.

☞ When you approach an intersection, the display automatically switches to an enlarged map of the intersection to help you drive through it. You can change the setting so that this enlarged map does not appear. For details, see “Zoom Map of Intersection” on page 87. (If set to Driver’s view, the display does not switch to an enlarged map of the intersection.)

If you stray from the route

If, for any reason, you stray from the suggested route, you can automatically search the route to get back on track. This function is called “Auto Reroute”, and you can set it On or Off in the Settings menu. For details, see Chapter 6.

- If “Auto Reroute” is set “Off” and the display is in mode except “Map mode”, when you stray from the route, the display automatically switches to “Map mode” and a map of your surroundings appears. When you return to the suggested route, the display returns to each mode, and route guidance restarts.
- If the new route requires you to travel in the opposite direction to your current heading, guidance informing you that you need to turn around to get back to the route is displayed.
- If you stray from the route being guided, and enter a new street not recorded in the disc, the Navigation System automatically switches to “Map mode”.

If you stop during the route guidance

If you stop at a petrol station, or a restaurant during the route guidance, your Navigation System remembers your destination and route information. When you start your car engine again, the route guidance resumes from your current location.

If you parked off the set route, the route guidance resumes when you return to the set route. Also the estimated time of arrival or travel time to your destination reappears when you return to the set route.

■ *When receiving traffic information ahead on the set route*

This device periodically checks the traffic information on the set route. When traffic information is received, the message appears on the display and is spoken by the voice guidance. Follow the instructions, and select the operation, such as searching detour. You can also check the reception of traffic information manually.

When receiving traffic information

For example, the message “There is <event> on the route within XX km. Do you want to reroute?” appears.

On this display, you can select the following items:

Yes : The route is recalculated taking the traffic jam into account.

No : The message disappears, and the map display reappears.

- You can also operate the Navigation System by speech. For details of voice operation, see Chapter 7.
- When new traffic information arrives, the message “Traffic information has just been updated” appears. If desired, check the new information. For details of how to do that, see “Confirming traffic information relevant to the current route” on page 74.
- After the message just described appears, if you do not check the new information within 10 seconds, the message disappears. Check a new message if necessary.
- You can set whether you want the message asking you if you want your Navigation System to search for a detour to appear. For details, see “Real Time Reroute Alert” on page 90.

When receiving an alert

When receiving an alert, the message “Alert message has just arrived. Do you want to check?” appears.

On this display, you can select the following items:

Yes : Detailed information appears.

No : The message disappears, and the map display reappears.

When confirming no traffic information manually

If you press the GUIDE button on the Remote Controller for more than three seconds, you can check traffic information about your route. If there is no traffic information about your route, the message informing you that no traffic information has been received is shown. In this case, the message disappears when you click the OK button.

Checking the Suggested Route

You can check information about the route between your current location and your destination.

1 Press the DETOUR button on the Remote Controller for over two seconds.

2 Check the contents on the display.

In Route Profile display, the names of the streets you drive through, and the driving distance of each street can be checked in order.

Route Profile

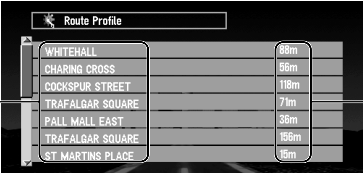

The screenshot shows a 'Route Profile' window with a list of streets and their corresponding driving distances. The streets listed are WHITEHALL, CHARING CROSS, COCKSPUR STREET, TRAFALGAR SQUARE, PALL MALL EAST, TRAFALGAR SQUARE, and ST MARTINS PLACE. The driving distances are 88m, 56m, 118m, 71m, 38m, 58m, and 19m respectively. A label 'Name of the streets you drive through' points to the street names, and a label 'Driving distance' points to the distance values.

Name of the streets you drive through	Driving distance
WHITEHALL	88m
CHARING CROSS	56m
COCKSPUR STREET	118m
TRAFALGAR SQUARE	71m
PALL MALL EAST	38m
TRAFALGAR SQUARE	58m
ST MARTINS PLACE	19m

3 Press the NAVI button.

The map of your surroundings reappears.

■ Checking the Suggested Route from the Information menu

You can also check the information about the route from the Information menu.

1 Select "Information" from the Main menu and select "Route Profile". Click the OK button.

2 Check the contents on the display.

3 Press the NAVI button.

Recalculating the Route to Your Destination

You can recalculate the route to avoid the traffic jam or road works ahead. You can set the length of the area, and avoid just that area, or you can even search a new route from the current location to your destination. (On the map screen during route guidance, try the following operations.)

- 1 Press the **DETOUR** button on the Remote Controller.
- 2 Select the distance from the list, and click the **OK** button.

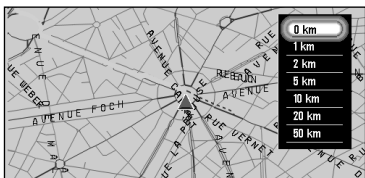

On this display, you can select the following items:

- 0 km/mi :** The route from the current position to your destination is recalculated.
- The distance of the detour :** The route is recalculated, avoiding the area the specified distance ahead of your current position.

Route calculation starts if you click the **OK** button.

- Distance of detour can be selected from 1 / 2 / 5 / 10 / 20 / 50 kilometres (1 / 3 / 5 / 10 / 30 / 50 miles). For details of switching the display between “km” and “mi”(miles), see “**KM/Mile Setting**” on page 87.
- Based on the traffic information received from RDS-TMC stations, you can set the automatic route calculation for avoiding the traffic jam. For details, see “**Avoid Traffic Route**” on page 90.

Canceling the Route Guidance

If you no longer need to go to your destination, or you want to set another location as your destination, carry out the following operations:

■ Delete the current route, and cancel the route guidance

If you no longer need route guidance, delete the current route, and cancel the route guidance.

- 1 Press the CANCEL ROUTE button on the Remote Controller.**
The message confirming whether to cancel the current route appears.
- 2 Select “Yes (all)” and click the OK button.**

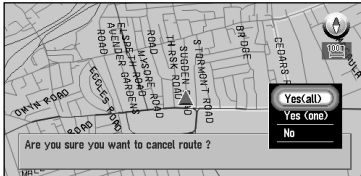

The current route is deleted, and the map of your surroundings reappears.

On this screen, you can also select the following items:

Yes (one) : Route is recalculated by canceling the selected via point.

No : Route will not be cancelled.

■ Changing your destination

If you want to change your destination during the route guidance, search the new destination, and set the route.

- 1 From Main menu, select “New Destination” and click the OK button.**
- 2 Search for the new destination.**
When the location search is completed, a message appears asking whether the location is your destination, or via point.
- 3 Select “New route” and click the OK button.**

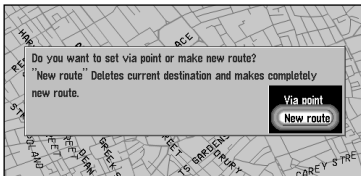

The route currently set is deleted, and a new route is calculated. If you do not want to delete the route, press the BACK button to return to the previous screen.

↪ When you delete the route, its via points are also deleted.

Adding Via Points to the Current Route

You can select via points (locations you want to visit on the way to your destination) and you can recalculate the route to pass this location.

■ Adding a via point

You can set up to five via points. This is achieved as follows :

1 Specify the location you want to visit.

You specify a via point in the same way as you specifying a destination (see Chapter 3). You can also scroll the map to display the Shortcut menu (see “Shortcut menu” on page 27), and use the location cross pointer to set a via point.

When the location is found, a message appears asking whether you want to set this location as your destination, or as a via point.

2 Select “Via point” and click the OK button.

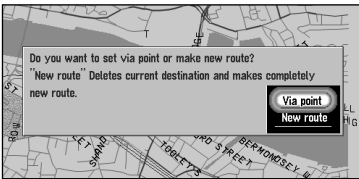

A list giving your currently set destination and its via points appears.

3 Confirm the contents of the list, and select “Done”. Click the OK button.



Route calculation with the specified location as a via point starts if you click the OK button.

On this display, you can select the following items:

Add : You can add more via points. Repeat the procedure from Step 2 above (you can add up to five via points).

☞ If you select “Map Search”, you can specify the location to register by showing a map.

Delete : You can delete via points from the list.

Sort : You can sort your destination and via points in the order of the nearest (distance in a straight line) from the current location.

■ **Skipping a via point**

You can opt for the next via point to be skipped, and the new route to be calculated accordingly.

- 1 **Press the CANCEL ROUTE button on the Remote Controller for more than two seconds.**

A message asking whether you want to skip the next via point appears.

- 2 **Select “Yes” and click the OK button.**

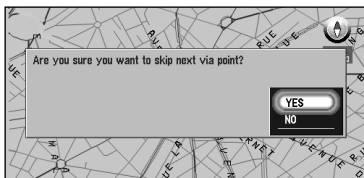

A new route to your destination through all the remaining via points, except for the skipped via point, is calculated.

■ **Deleting a via point from the route**

If you no longer need to pass a via point on the set route, the via point can be deleted from the list of via points, and the route can be recalculated.

- 1 **Press the CANCEL ROUTE button on the Remote Controller.**

A message asking whether you want to cancel the route appears.

- 2 **Select “Yes (one)” and click the OK button.**

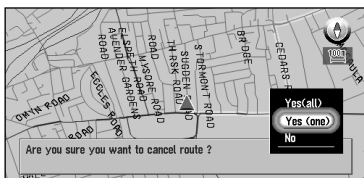

The list of via points currently set appears.

- 3 **Select the via point you want to delete and click the OK button.**

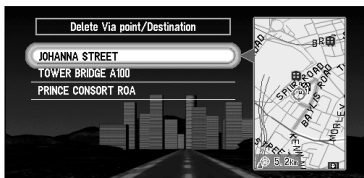

- 4 **Select “Delete” and click the OK button.**

You can select the following item:

Sort : You can sort your destination and via points in the order of the nearest (distance in a straight line) from the current location.

➤ If you want to delete other via points, repeat Steps 3 and 4 above.

5 Select “Done” and click the OK button.

A new route to your destination via the remaining via points is calculated.

Displaying Certain Points Of Interest on the Map

Selected Points Of Interest (POI) in a certain category can be shown on the map, and you can check the location on the display while driving.

- 1 **Select “Information” on Main menu, and then select “Overlay POI”. Click the OK button.**

The list of POI categories appears.

- 2 **Select the category and click the OK button.**

The selected item is ticked. If you want to register other categories, repeat this step.

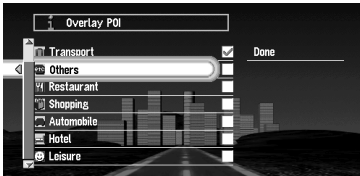

- 2

↳ If you want to search with more detailed categories, move the joystick left to display the list of subcategories. If you select the sub-category you want to show on the map and click the OK button, a check mark appears on the right hand side of the selected sub-category. Select “Done” and click the OK button to return to the list of POI category.
- 3 **When you have finished selecting categories, select “Done” and click the OK button.**

POIs in the selected category appear on the map.

↳ If you want to set a POI as your destination, point to the location with cross pointer, and click the OK button. Then select “Destination” from the Shortcut menu. (see “Shortcut menu” on page 27). Information around the cross pointer appears at the bottom of the screen. Use the scale controller to switch the items, and show the information of the selected POI. When this is done, the POI mark on the map is framed by a flashing red square. If you press the OK button, the route to this POI is calculated.

Utilising Various Information

Editing the Address Book

The Address Book stores information about the following types of location. You can edit the contents of the Address Book.

- **Last Destination** - the destination whose route was set most recently.
- **Destination History** - destinations and via points you have searched in the past.
- **Registered Locations** - a manually registered location, such as your home, your favourite location, or the location whose information was edited, such as renaming.

■ Registering a previous location in the Address Book

Once searched, destinations or via points are automatically memorised and stored in the Address Book as Destination History. When the number of locations exceeds 100, the oldest location is overwritten automatically. Therefore, to ensure that a particular location is kept in the Address Book, you must register it manually as Registered Locations.

Information edited as described in “Editing a location’s information” below is also automatically registered in the Address Book. Once the location is registered, you can set the route to this location by voice operation.

- 1 Select “Address Book” in the Main menu and click the OK button.
- 2 Select the location you want to register in the Address Book and move the joystick to the left.

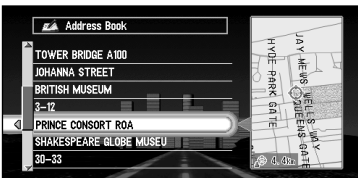

- 3 Select “Registration” and click the OK button.

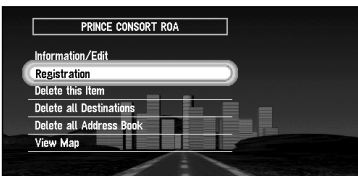

A message asks whether you want to rename the location.

4 Select “Yes” and click the OK button.

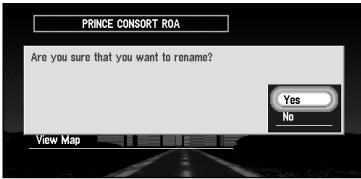

Alternative option:

No : If you do not need to rename, select “No”. The name of the location registered in the Address Book is unchanged, and the Address Book menu appears.

5 Enter a new name; select “OK” and click the OK button.

The name of the current location appears in the text box. Delete the current name, and type a new name between 6 and 23 characters long. (For the details of entering characters, see “How to use text palette” on page 30.)

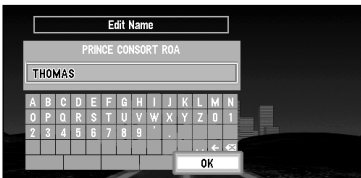

When you click the OK button, a message confirming the new name appears, and a voice message confirming the pronunciation of the name is played.

6 If the pronunciation is correct, select “Yes” and click the OK button.



The details you set are registered, and the Address Book menu appears. On the map, a pin mark appears at the registered location. (You can change this mark.)

On this display, you can select following options:

No : Select to return to the display for entering characters.

Repeat : You can reconfirm the pronunciation of the name you entered.

- In the Address Book, you can register up to 98 locations, except your home and your favourite location.
- You can also store locations registered in the Address Book on a PC card. see “Storing the data of registered locations in the PC card” on page 78.

■ Editing a location's information

Select a location in the Address Book menu and move the joystick to the left: the Address Book Operate menu appears. If you edit the information of the locations stored in Last Destination or Destination History, it is registered in Address Book as Registered Location. To edit the information about the location:

- 1 Select “Address Book” in the Main menu and click the OK button.**
The Address Book menu appears.
- 2 Select the location to edit the information and move the joystick to the left.**
- 3 Select “Information/Edit” and click the OK button.**



Click the OK button, and the Address Information menu appears. Refer to the item corresponding to the subsequent operation. After finishing the operation, the display shown in Step 2 appears. You can continue to edit other information items if necessary.



1. Name

The name can be used as a command for voice operation.

2. Address

The address is registered when the search was made for the first time. (Not editable.)

3. Phone number

4. Pictograph

The symbol displayed on the map.

5. Sound

If you select sound in the menu, an alert sounds as you approach 500m radius from the location.

➤ Apart from the Address, these items can be edited freely.

Changing a name

- 1 Select “Edit Name” and click the OK button.**

Refer to Step 5 in “Registering a previous location in the Address Book” above for the next steps.

➤ You cannot change the name of your home.

Entering or changing a phone number

- 1 Select “Edit Phone Number” and click the OK button.
- 2 Enter a phone number; select “OK” and click the OK button.
The Address Information menu appears.
 - To change a registered phone number, delete the existing number and then enter a new one.
 - You can enter a telephone number of up to 24 digits.

Selecting a pictograph to appear on the map

- 1 Select “Select Pictograph” and click the OK button.
- 2 Select the Pictograph; select “Done”, and click the OK button.
The Address Information menu appears.
 - You cannot change the mark of your home or of your favourite location.

Selecting sound

- 1 Select “Select Sound” and click the OK button.
- 2 After selecting the sound, select “Done” and click the OK button.
After the selected sound is played, a message asks whether you want to set it.
- 3 Select “Yes” and click the OK button.



The Address Information menu appears.

Alternative option:

Repeat : You can hear the selected sound again.

No : You can select another sound by going back to Step 2.

■Deleting the data in the Address Book

You can delete items contained in the Address Book. You can also delete all the data at once.

- 1 In the Address Book menu, select the location to delete and move the joystick to the left.
- 2 Select the deletion method.

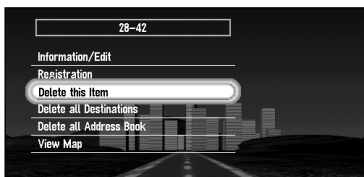

A message confirming deletion appears, if you click the OK button.

On this display, you can select the following options:

Delete this item : Delete the location selected in Step 1.

Delete all Destinations : All the items stored in Last Destination and Destination History are deleted.

Delete all Address Book : Delete all the data in the Address Book.

3 Select “Yes” and click the OK button.

The data you selected is deleted, and the Address Book menu appears.

Alternative option:

No : The display shown in Step 2 appears.

⤷ Because deleted data cannot be restored, take extra care not to select “Delete All Destinations” and “Delete all Address Book” by mistake.

■ **Confirming the location contained in the Address Book on the map**

You can select a location in the Address Book and display its surroundings on the map.

- 1 Select the location to edit in the Address Book menu and move the joystick to the left.
- 2 Select “View Map” and click the OK button.

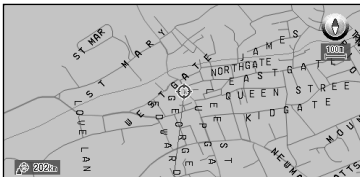

The map of the selected area and its surroundings appears.

Registering Your Home and Your Favourite Location

By registering your home and your favourite location, you can easily calculate the route by single press of the button from the Main menu. You might find it useful to register your workplace or a relative's home as your favourite location.

■ Registering a location

Before you can search for a route home or to your favourite location, you must first register the location. Registering your favourite location for the first time is described here. You can change the registered information later.

- 1 **Select “Settings” in the Main menu, then select “Others”, and “Go to ~”. Click the OK button.**

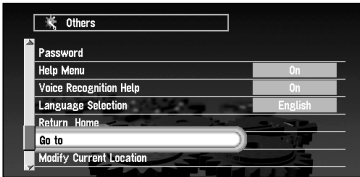

You can select a method of location search on the display.

- When registering your home location, select “Return Home” and click the OK button.
- 2 **Search for a location and display a map.**

The search method is the same as that for your destination (see Chapter 3).

 - If you select “Map Search”, you can specify the location to register by showing a map.
 - 3 **Point the cross pointer to the location you want to register and click the OK button.**

A message “Is this your specific place?” appears.

 - If some items around the cross pointer is picked up, you can switch between multiple items by turning the scale controller up or down. After selecting the item, click the OK button.
 - 4 **Select “OK” and click the OK button.**

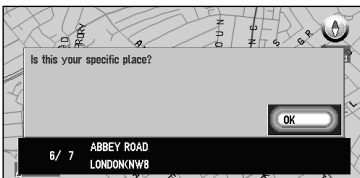

A message confirming the name of the location appears. (However, you cannot change the name of your home.)

- If the location is your home, click the OK button to register the designated location as your home, and the Others menu appears.

5 Select “Yes” and click the OK button.

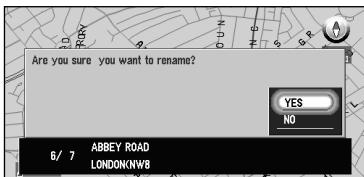

- ☞ If renaming is not necessary, at this step, select “No” and click the OK button. The location is registered, and the Others menu appears.

6 After entering a new name, select “OK” and click the OK button.



A message confirming the entered name appears, and a voice message confirming the pronunciation is played.

7 If the pronunciation is correct, select “Yes” and click the OK button.



A specific place is registered as your favourite location, and the Others menu appears. Switch to Main menu, an item “Go to . . .” is changed to the item “<favourite location name>”.

Afterwards, you can set a route by selecting this item and clicking the OK button.

- ☞ During voice operation, you can get a route calculated by saying the entered name. For the details of voice operation, see Chapter 7.

■ **Changing or deleting your home or your favourite location**

Changing your favourite location is described next.

- 1 **Select “Settings” in the Main menu, then select “Others” and “<favourite location name>”. Click the OK button.**

If you click the OK button, a message confirming that you want to change a registered location appears.

➤ To change your home location, select “Return Home” and click the OK button.

- 2 **Select “Change” and click the OK button.**

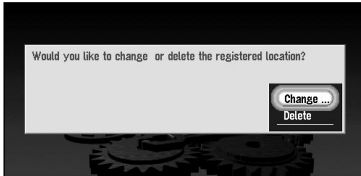

A display for selecting the search method appears. See “Registering a location” above for the next steps.

Alternative option:

- Delete :** Select “Delete” to delete your favourite/home location. A message asking you to confirm the deletion appears, and then select “Yes” and click the OK button. Your favourite location is deleted, and the Others menu appears.

Registering a Password

If you register a password, only those who know the password can use your Navigation System.

- 1 **Select “Settings” in the Main menu, then select “Others” and “Password”. Click the OK button.**
- 2 **Enter a password.**
Carefully enter each character. A password must be between 6 and 24 characters (alphabetic or numeric).

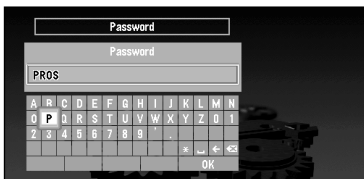

- 3 **Select “OK” and click the OK button.**
A message confirming the password appears, and a voice message confirming the pronunciation is played.
- 4 **If the pronunciation is correct, select “Yes” and click the OK button.**



The entered password is set, and the Others menu appears.

When your Navigation System is activated, a display for entering your password appears. (see “Switching On and Off” on page 25.)

- ⌚ If you want to change your password, at first enter the password that is currently set. (You cannot enter using the numeric keypad.) When the display for entering your password appears again, enter the new password.
- ⌚ Once the password is registered, you can use the voice operation for the Navigation System to recognise the password.
- ⌚ If you change the language used, the set password is cleared. If desired, set the password again.
- ⌚ In order not to forget your registered password, write it down on the sheet at the back of this manual, and remove it and store in a safe place. If you forget your password, consult the shop or your dealer.

Setting Areas to Avoid

If you register Areas to Avoid, such as crowded intersections or congested areas, routes can be calculated that avoid those areas. Areas to Avoid can be set from the Settings menu.

Caution

If you register or delete an Area to Avoid after setting a route, the contents of route guidance may be changed due to activation of Auto Reroute function.

■ Registering an Area to Avoid

This section describes a way of registering an Area to Avoid for the first time. You can register up to five Areas to Avoid.

- 1 **Select “Settings” in the Main menu, then select “Route Guidance” and “Areas to Avoid”. Click the OK button.**

The list of Areas to Avoid appears.

- 2 **Select one of the items shown in “New Area- . . .” and click the OK button.**

When registering for the first time, any item on the list is shown as “New Area - (number in range 1 to 5)”.



A message to specify a search method for a location appears.

- If you register an Area to Avoid after setting a route, the message asks whether you want to recalculate the current route. Select “Yes”, click the OK button, and proceed to the next step.

- 3 **Search for a location for registration and display a map.**

The search method is the same as that of searching for your destination (see Chapter 3). Once a search is complete, a map with the specified location at its centre appears.

- If you select “Map Search”, you can specify the location to register by showing a map.

- 4 **Move the scale controller to set the size of the Area to Avoid.**

The larger the map, the more detailed Area to Avoid can be specified. The smaller the map, the wider the area can be specified.

The maximum size of an Area to Avoid is 1 square kilometre (3.4 square miles).

- When setting the Area to Avoid, operate with the scale of the map between 25m and 1km. With other scale ranges, you cannot to set the Area to Avoid.

5 After specifying an Area to Avoid, click the OK button.

The Area to Avoid is enclosed in a red frame. Scroll the map to adjust the position of the red frame.



6 Select “Register” and click the OK button.

The specified area is registered as an Area to Avoid, and the display shown in Step 2 appears. The name of the specific place appears in the list.

- If you want to register another Area to Avoid, repeat Steps 2 to 6.
- If you want to stop registration, push the BACK button. The previous menu appears.

⤷ Depending on the setting of route search conditions, you may not be able to avoid the specified areas. In that case, the message “Your journey cannot avoid the specified area” appears. For details, see “Route Setting Information” on page 109.

■ Changing or deleting an Area to Avoid

You can subsequently change/rename/delete the Area to Avoid.

1 Select “Settings” in the Main menu, then select “Route Guidance” and “Areas to Avoid”. Click the OK button.

The list of Areas to Avoid appears.

2 Select an area you want to change or delete, and click the OK button.

3 Select “Yes” and click the OK button.

The map of the Area to Avoid and the list of operations related to this area appears.

4 Select the desired operation and click the OK button.



On this display, you can select the following options:

Rename : Changing a name. After entering a new name, select “OK” and click the OK button; the Route Guidance menu appears.

Change Area : A specified area can be changed. For the next steps, see Step 2 onwards in the “Registering an Area to Avoid” above.

Delete : Delete the selected Area to Avoid and return to the list of Areas to Avoid.

Using Traffic Information

You can confirm the traffic information transmitted from the FM radio service through Radio Data System (RDS) on the display. Such traffic information is updated periodically. When you receive traffic information about your route, the Navigation System automatically displays the popup message informing you of the traffic information. Also, on this screen, you can select whether to recalculate the route to avoid the traffic jam. (In this case, route calculation is carried out by considering the traffic information within a 100 km radius from your current location.)

■ Confirming traffic information relevant to the current route

- 1 Select “Information” in the Main menu, then select “RDS-TMC” and “View Traffic Information”. Click the OK button.

The list of received traffic information is shown.

➤ By pressing the GUIDE button on the Remote Controller for more than three seconds, you can check the traffic information of your route. If there is no traffic information, the message appears saying that no traffic information is received. In such a case, if you click the OK button, the message disappears.

- 2 Select the information you want to see from the list.

The names of the streets in the place containing the information are displayed alphabetically in the list.

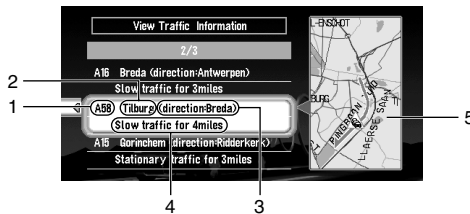

1. Street name
2. Place name
3. Direction to the spot
4. Traffic information
5. Map of the spot

If you find any item to confirm the details, select the item with the following method:

- Click the OK button, detailed information can be verbalised see “Confirming verbalised information regarding traffic” below).
- Move the joystick to the left, and detailed information can be confirmed on the map (see “Confirming traffic information on the map” below).

- 3 Once the information is checked, press the BACK button.

A list of traffic information appears.

➤ When traffic information is updated, a message saying “Traffic information has just been updated” appears. If no operation is done within 10 seconds, the message disappears. Confirm updated information as necessary.

Confirming verbalised information regarding traffic

The following information appears:

- Street name
 - Site name (The first and the last names of the cities involved in the traffic jam and the direction of the traffic jam are shown.)
 - Traffic information (Example: “3km slow-going traffic”)
- ☞ If the information cannot be displayed in one screen, select “◀◀” or “▶▶” and click the OK button to view the rest of the information.
- ☞ To display details of an adjacent event, select “◀” (previous event) or “▶” (subsequent event) and click the OK button.

Confirming traffic information on the map

When traffic information appears on the map, the following information appears:

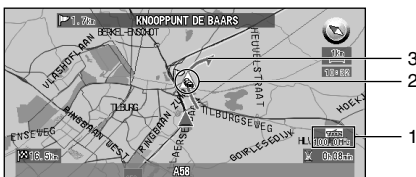

1. Name of the radio station or frequency currently being received, and elapsed time since the last reception (within 5 minutes = green, between 5 and 20 minutes = red, 20 minutes or more = not displayed)
2. Icon to indicate the presence of traffic information (appears only when the scale on the map is under 1 km)
3. An arrow to indicate the area of traffic jam (displayed only when the scale on the map is under 1 km)

If you want to view detailed traffic information, point the cross pointer at the traffic information icon and click the OK button. When the Shortcut menu appears, select “Information” and click the OK button. You can check the information such as a place name.

- ☞ If the name of the radio station or frequency cannot be shown, bad reception may be the cause. See “Selecting the radio station” explained below for retrieving the information from another radio station.

■ **Selecting the radio station**

The RDS-Tuner of this unit automatically tunes to the radio station to receive available traffic information. If reception is poor, you can switch to another station manually. Once the receiving radio station is selected, the system automatically tunes to stations that provide traffic information according to the trace of a driving vehicle.

Tuning to a radio station with good reception

- 1 Select “Information” in the Main menu, then select “RDS-TMC” and “Manual Station Search”. Click the OK button.**
- 2 Select “Next” and click the OK button.**

Available radio stations can be searched automatically. If a radio station with a good reception is found, the tuning mode is stopped and the tuned station name (frequency) is displayed.



Alternative option:

Store : The tuned station is stored in the list of the preset radio stations (see “Registering a radio station” below).

↪ If you want to continue to search for another station, repeat this procedure.

- 3 Select “Done” and click the OK button.**
After switching to a selected radio station, a map of your surroundings appears.

Registering a radio station

If you register frequently used stations in advance, you can easily tune to one from the list. This section describes how to register a radio station for the first time.

- 1 See Steps 1 and 2 in “Tuning to a radio station with good reception” above for selecting a desired station.**
- 2 Select “Store” and click the OK button.**



If you click the OK button, the station selected in Step 1 is registered, then a map of your surroundings appears. The next time the list of the radio stations is displayed, the name of this station appears in the list.

- ⤷ If there are already five stations registered on the list, select one to be overwritten by the details of the newly selected radio station. When you click the OK button, a message confirming that you want to overwrite the data appears. Select “Yes” and click the OK button to overwrite the unwanted station.

Selecting from pre-registered radio stations

You can pre-select up to five radio stations (Preset Station). From the list of the radio stations, you can select the one you want to receive.

- 1 Select “Information” in the Main menu, then select “RDS-TMC” and “Recall Preset Station”. Click the OK button.**

The list of registered radio stations appears. This list of broadcasting stations (Preset Station) cannot be used unless broadcasting stations are stored.

- 2 Select a radio station and click the OK button.**

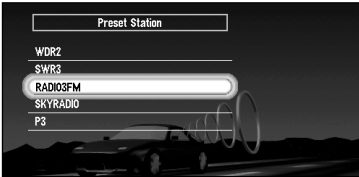

After switching to the specified radio station, a map of your surroundings appears.

Using a PC Card

You can store data in the Address Book in a PC card, which can also be read by this unit. It is very useful when you want to share the data in the Address Book with your friends or to store the data for backup.

Before using a brand new card, you must initialise it, as described next.

■ Initialising a PC card

- 1 Select **“Settings”** in the Main menu, then select **“PC Card”** and **“Initialise PC card”**. Click the **OK** button.

A message asking you to confirm the initialisation of the PC card appears.

- 2 Select **“Yes”** and click the **OK** button.

Once initialisation is complete, a message to select the operation of the PC card automatically appears. (If you want to cancel the initialisation, select **“No”**.)

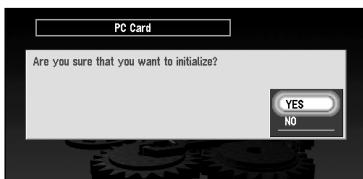

⤴ Do not stop the engine until initialisation of the PC card is complete.

■ Storing the data of registered locations in the PC card

You can select any item registered in the Address Book and store the data in the PC card. Data can be stored in the corresponding group. A new group can be created. (However, if nothing is registered in Registered Locations in Address Book, you cannot use this function.)

This section describes a method of creating a new group and storing the data of the registered location into the group.

⤴ The volume of data you can register depends on the capacity of the PC card.

- 1 Select **“Settings”** in the Main menu, then select **“PC Card”** and **“Store on PC card”**. Click the **OK** button.

The list of locations registered in the Address Book appears.

- 2 Select the desired item for storage and click the **OK** button.

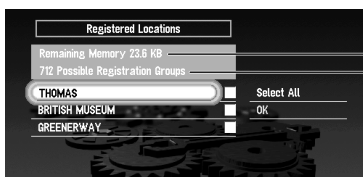

— Free space in the PC card
— Number of groups you can store

The selected item is ticked. To register other locations, repeat this step.

Alternative option:

Select All : All the locations are selected at once.

- 3 After finishing the selection of locations, select “OK” and click the OK button.
The list of the stored group appears.

- 4 Select “New group” and click the OK button.

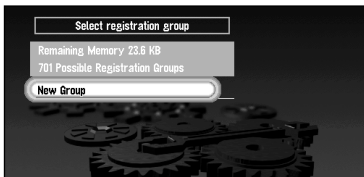

The display to enter a new group name appears.

- ☞ If the data is to be stored in a group already registered in the PC card, select the group name in the list and click the OK button. (Up to 100 items per group can be registered.) A message confirming that you want to store the data in the specified group appears. Click the OK button, and the data is stored in the PC card, and a map of your surroundings then appears.

- 5 After entering a group name, select “OK” and click the OK button.



The data of the registered location is stored in the entered group, and a map of your surroundings appears.

- ☞ If there is little or no space in the PC card or you have already stored 100 locations in a group, a message, “Memory is full”, or “You cannot store more than 100 items in the same group” appears. To remedy, delete unnecessary data, or create a new group.

■ Loading data from a PC card

Address Book data stored in a PC card is loaded to the Navigation System. (However, if there is no data of Registered Locations in the PC card, you cannot use this function.)

- 1 Select “Settings” in the Main menu, then select “PC Card” and “Read from PC card”.
Click the OK button.
The list of groups to be stored appears.
- 2 Select the desired group and click the OK button.
The list of locations stored in the group appears.
- 3 Select the desired locations and click the OK button.

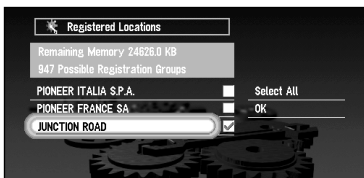

Selected items are ticked. To load the data from other locations, repeat this step.

Alternative option:

Select All : A whole group can be selected.

4 Select “OK” and click the OK button.

After the data of the selected locations is stored in the Address Book, a map of your surroundings appears.

- If the total number of data items loaded from a PC card and data items registered in the Address Book exceeds 100, a message indicating that no more data can be registered appears. In that case, delete unnecessary data or decrease the number of data items loaded from a PC card.

■ **Deleting PC card data**

You can delete data for a specified location or a whole group. (However, if there is no data of Registered Locations in the PC card, you cannot use this function.)

1 Select “Settings” in the Main menu, then select “PC Card” and “Delete PC card data”. Click the OK button.

2 Select a group where the location you want to delete is stored and click the OK button.

A list of locations stored in the specified group appears.

3 Select a location you want to delete and click the OK button.

The selected location is ticked. To delete other locations, repeat this step.

Alternative option:

Select All : Select all locations in a group.

4 Select “OK” and click the OK button.

A message confirming that a specified location is deleted appears.

5 Select “Yes” and click the OK button.

After a specified location is deleted, a map of your surroundings appears.



Checking the Navigation Status

The navigation status, including the driving status of a vehicle, positioning status by satellite, learning status of the sensor, and cable connection status can be checked.

■ Checking positioning information by satellite

Your Navigation System uses positioning data transmitted from GPS satellites. GPS reception status can be checked on the screen.

- 1 **Select “Information” in the Main menu, then select “Location Status” and “GPS Status”.** Click the OK button.

The GPS Status screen appears.



1. Position of a satellite and radio wave reception status

The position of a GPS satellite from which currently received data is shown. The satellite used for positioning is shown in orange, any other satellites from which data is currently being received are shown in yellow, and satellites from which data cannot be received are shown in black.

2. Longitude and latitude

If current positioning is not available, the longitude and latitude measured last is shown.

3. Current date, time, and a day of a week

4. Positioning status by GPS satellite (2-dimension, 3-dimension, etc.)

Current positioning status is shown. The status depends on data reception status from a GPS satellite.

- 2 **Push the BACK button.**

The previous screen appears.

■ Checking sensor learning status and driving status

To improve the precision of navigation, the system learns the driving status of your vehicle and stores the data in the internal memory. The learning status of the sensor can also be checked on the screen. The current driving status, including vehicle speed and inclination of a road, can be checked on the screen.

- 1 Select “Information” in the Main menu, then select “Location Status” and “3D Calibration Status”. Click the OK button.

The 3D Calibration Status screen appears.

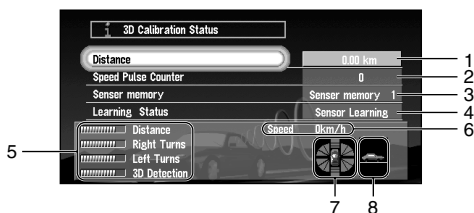

1. Distance

Driving distance is indicated.

2. Speed Pulse Counter

Total number of speed pulses is indicated.

3. Sensor memory (Memory1/Memory 2)

Memory currently used is indicated.

- Your Navigation System can learn the driving status of tyres for summer and winter independently by using the different memories. To change memories, select “Sensor memory” and click the OK button. Then select “Memory-1” or “Memory-2”, which you want to use, and click the OK button.

4. Learning Status

Current driving mode is indicated.

5. Degree of learning

Learning situations of Distance, Right Turn, Left Turn, and 3D detection are indicated by the length of bars.

6. Speed

Speed detected by this unit is indicated. (This indication may be different from the actual speed of your vehicle, so please do not use this instead of the speedometer of your vehicle.)

7. Front and back G/Rotational speed

Accelerated velocity of your vehicle to front / back direction is indicated. Also, rotational speed when your vehicle turns to left or right is shown.

8. Inclination

Degree of slope of a street is indicated.

2 Push the BACK button.

The previous screen appears.

To clear the memory...

If you want to delete the memorised learning contents of “Distance”, “Speed Pulse Counter”, or “Learning Status”, perform the following procedure:

- 1 Select the item you want to delete, and click the OK button.
- 2 While “Clear” is highlighted, click the OK button.

■ **Checking the connections of leads and installation positions**

Check that cables are properly connected between the main unit and the vehicle. Please also check whether they are connected in the correct positions.

- 1 Select “Information” in the Main menu, then select “Location Status” and “Connection Status”. Click the OK button.

The Connection Status screen appears. Either “OK” or “No good” appears on the screen, and connection status of each cable is shown.



1. Speed Pulse

The number of the Speed Pulse detected by this unit is shown. “0” is shown while the vehicle is stationary.

2. GPS Aerial

The connection status of GPS antenna and the sensitivity are shown. If “No good” is displayed, check the connection status of GPS antenna.

3. Installation Position

The Installation position of the main unit is shown. If “No good” is displayed, refer to “Installation Manual” for the installation position.

4. Handbrake

When the parking brake is applied, “On” is displayed. When the parking brake is released, “Off” is displayed. Keep the foot brake on while checking that the parking brake connection works properly.

5. Voltage

The power supply (reference value) provided from the vehicle battery to this unit is shown. If the voltage does not fall within the range of 11 to 15V, check that power cable connection is correct.

6. Illumination

When the lamps of a vehicle illuminate, “On” is displayed. When the lamps of a vehicle go out, “Off” is displayed. (If the orange/white lead is not connected, “Off” appears.)

7. Back Signal

When the selector lever is shifted to “R”, the signal switches to “High” or “Low”.

Check that it is properly displayed when the selector lever is shifted with the brake pedal depressed if the reversegear signal input lead (see “Installation Manual”) is connected.

2 Push the BACK button.

The previous screen appears.

Customising Your Navigation System

Modifying the Default Settings

You can tailor default settings such as navigation functions and information display for ease of use.

The following example describes how to change settings. In this example, the “Avoid Motorway” function under “Route Guidance” settings is turned on.

- 1 **Select “Settings” in the Main menu, then select “Route Guidance” and click the OK button.**

The Route Guidance menu appears. In the list, the settings are shown on the left, and the status of each setting is shown on the right. “Off” appears to the right of the “Avoid Motorway” setting, showing that this function is set off.

- 2 **Select “Avoid Motorway” and click the OK button.**
- 3 **Using the joystick, select “Off” to the right of “Avoid Motorway”, and click the OK button.**



A list of options possible to select under “Avoid Motorway” appears.

- 4 **Using the joystick, select “On” and click the OK button.**

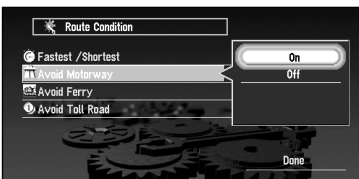

- 5 **Select “Done” and click the OK button.**

The list of settings disappears, and the display turns to the one shown in step 2. The status to the right to “Avoid Motorway” is now “On”. If you want to change other settings, select the setting you wish to change, and repeat the operations described in Steps 2 to 5.

➤ Press the NAVI button to return to the map of your surroundings.

Items Users can Change

The Settings menu contains the Route Guidance, Map Display, Hardware, Others, RDS-TMC, and PC Card menus. If you select a menu name in the Settings menu, an equivalent menu appears. In the menu screen, the contents of the current setting is shown on the right-hand side of each item.

This section describes the details of the setting for each menu. Settings marked with an asterisk (*) show that they are default or 'factory' settings.

☞ For PC card menu, see "Using a PC Card" on page 78.

■ Route Guidance menu

Auto Reroute

This setting controls whether, when you stray from the guided route, the system automatically recalculates the route to your destination.

On* : Auto Reroute function is turned on.

Off : Auto Reroute function is turned off.

Areas to Avoid

Setting or change of Areas to Avoid is performed (see "Setting Areas to Avoid" on page 72).

Route No.

This setting controls whether, during a route calculation, the system calculates one route only, or whether it calculates six route options, one of which you select.

1* : Route options are not shown, and only one route judged as being optimum by your Navigation System is calculated.

6 : Six route options are calculated.

Fastest/Shortest

This setting controls conditions for calculating a route.

Shortest : Calculate a route with the shortest distance to your destination as a priority.

Fastest* : Calculate a route with the shortest travel time to your destination as a priority.

Avoid Motorway

This setting controls conditions for calculating a route.

On : Calculate a route that avoids motorways.

Off* : Calculate a route that may include motorways.

☞ Even when the setting of "Avoid Motorway" is turned "On", a route using the motorway may be set if your destination is far away.

Avoid Ferry

This setting controls conditions for calculating a route.

On : Calculate a route that avoids ferries.

Off* : Calculate a route that may include ferries.

Avoid Toll Road

This setting controls conditions for calculating a route.

- On :** Calculate a route that avoids toll roads.
- Off* :** Calculate a route that may include toll roads.

KM/Mile Setting

This setting controls the unit of distance displayed on your Navigation System.

- KM* :** Show distances in kilometres.
- Mile :** Show distances in miles.
- Miles & Yards :** Show distances in miles and yards.

Zoom Map of Intersection

This setting controls whether, when your vehicle is approaching an intersection, an enlarged map of the intersection and its surroundings appears.

- On* :** Display switches to an enlarged map.
- Off :** Does not switch to an enlarged map.

Average Speed (General Road)

This setting controls the estimated average speed when driving on a general road, which is used for calculating the Estimate Time of Arrival (ETA) and travel time to your destination.

- When the “KM/Mile Setting” is set to “km”, select one from “**40 km/h**”, “**60 km/h**”(*), or “**80 km/h**”.
- When the “KM/Mile Setting” is set to “mile”, select one from “**30 mile/h**”, “**40 mile/h**”(*), or “**50 mile/h**”.

Average Speed (Motorway)

This setting controls the estimated average speed when driving on a motorway, which is used for calculating the Estimated Time of Arrival (ETA) and travel time to your destination.

- When the “KM/Mile Setting” is set to “km”, select one from “**100 km/h**”, “**120 km/h**”(*), “**140 km/h**”, or “**160 km/h**”.
- When the “KM/Mile Setting” is set to “mile”, select one from “**70 mile/h**”, “**80 mile/h**”(*), “**90 mile/h**”, or “**100mile/h**”.

Guidance Voice

You can change the gender of the guidance voice. You cannot change the gender during route guidance, so change this setting when route guidance is not active.

- Male :** Guidance voice changes to a male voice.
- Female* :** Guidance voice changes to a female voice.

■ **Map Display menu**

Map Orientation

This setting controls whether the map is shown with the driving direction upward, or with North at the top.

Heading Up* : To ensure that the driving direction always faces up, the map automatically rotates according to the direction of your vehicle.

North Up : The map is always displayed with North at the top.

Map Display

To improve the visibility of the map during the evening, you can change the combination of the colours of the map.

Illumination* : You can change the combination of the colours of a map according to whether the vehicle lights are On or Off.

Day Display : The map is always displayed with bright colours.

Tracking Display

Timing for deleting tracking can be set.

On (always) : Display tracking for all journeys.

On (this journey) : Display tracking dots but erase them when the navigation system is turned off (when cutting the engine of your vehicle).

Off* : Do not display tracking dots.

■ **Hardware menu**

Hardware Volume

The volume of voice guidance played by your Navigation System can be set. To change the volume, select “+” or “-” with the joystick and click the OK button.

Monitor Type

The scanning type can be set according to the type of a display used. If the screen of the display you are using is blurred, change this setting to the one that gives the clearer display.

Type A* : Non-interlaced type. (When using Pioneer’s display, choose this setting.)

Type B : Interlaced type.

■ **Others menu**

Demo Mode

This is a demonstration function for shops. After a route is set, the simulation of the route guidance to a destination is automatically displayed. Normally, set this to “Off”.

On (Repeat) : Demo Mode is set on.

Off* : Demo Mode is set off.

Mute on Voice Recognition

This can be set when your Navigation System is combined with the Pioneer Head Unit with a muting function (one that has an Yellow/black lead). This setting controls whether the volume of the Head Unit is automatically muted during voice operation.

On* : During voice operation, the volume of the Head Unit is muted automatically.

Off : The volume of Head Unit stays the same during voice operation.

Mute on Voice Guidance

This can be set when your Navigation System is combined with the Pioneer Head Unit with a muting function (one that has an Yellow/black lead). This setting controls whether the volume of the Head Unit is automatically muted during voice guidance.

- On*** : During voice guidance, the volume of Head Unit is muted automatically.
- Off** : Volume of Head Unit stays the same during voice guidance.

British Summer Time

Whether to apply summer time is set. The time difference (+, -) between the time originally set in this unit (Paris Standard Time) and the current location of your vehicle is set here. (For details, see “Setup 3: Installing the Program” on page 22.)

- On** : Summer time is taken into account.
 - Off*** : Summer time is not taken into account.
- ☞ When the period of summer time comes, or when the summer time ends, this unit does not automatically change the summer time setting. See “Setup 3: Installing the Program” on page 22 and change the summer time setting.

Current Time

This setting controls whether to display the current time on the screen.

- On*** : The current time is shown.
- Off** : The current time is not shown.

Travel Time Display

Displaying the Estimated Time of Arrival or Travel Time from the current location to your destination on the screen is set.

- ETA*** : The Estimated Time of Arrival is shown.
 - Travel Time** : Travel time to your destination is shown.
 - Off** : Neither ETA nor Travel Time are shown.
- ☞ When moving to the area with different time zone, this unit does not automatically change the time display, etc., for each time zone. see “Setup 3: Installing the Program” on page 22 and change the time setting.

Password

Registering and changing the password (see “Registering a Password” on page 71).

Help Menu

This setting controls whether, if there are a few seconds of inactivity during menu operation, the Help Menu is displayed.

- On*** : The Help Menu is shown.
- Off** : The Help Menu is not shown.

Voice Recognition Help

This setting controls whether the list of available voice commands is displayed during voice operation.

- On*** : The list of commands is shown.
- Off** : The list of commands is not shown.

Language Selection

The language displayed can be set (see “Setup 3: Installing the Program” on page 22). Once you change the language, installation of the program starts.

Caution

Once the installation of the program starts, do not stop the engine of your vehicle until the installation is completed.

☞ If you change the language used, the set password is cleared. If desired, set the password again (see “Registering a Password” on page 71).

Return Home

Registering and changing your home location (see “Registering Your Home and Your Favourite Location” on page 68).

Go to ...

Registering and changing your favourite location (see “Registering Your Home and Your Favourite Location” on page 68).

Modify Current Location

Move the joystick to up/down or left/right to adjust the current location of your vehicle and direction displayed on a map.

Adjust Display Position

The display position of the screen of your Navigation System is adjusted. To adjust the screen, move the joystick up/down and left/right. Adjust to the optimal position, making sure that all four corners of the display are visible.

■ RDS - TMC menu

Real Time Reroute Alert

This setting controls whether, when a traffic jam on the set route is received, to display a message. On this message, you can select whether to calculate a route by taking traffic jam into account.

On* : Confirming message is displayed.

Off : Confirming message is not displayed. Route calculation is not carried out, when a traffic jam occurs on the route.

Avoid Traffic Route

This setting controls whether, when a traffic jam occurs on the route, to calculate a route by taking traffic jam into account.

On* : Route calculation is carried out by taking a traffic jam into account.

Off : Route calculation is carried out without taking a traffic jam into account.

Operating Your Navigation System with Voice

Basics of Voice Operation

Your Pioneer Navigation System comes with the latest in voice recognition technology. You can use voice commands to operate many of its functions. This chapter describes where you can use voice commands, and also what commands the system accepts.

Flow of voice operation

You can start voice operation any time when the screen under route guidance or a map is displayed (even when the map is scrolling).

The basic steps of voice operation are as follows. The steps are almost the same as when using the Remote Controller.

1. Press the TALK button to activate voice operation.
↓
2. Speak a command into the microphone.
↓
3. When the command is recognised, it is repeated.
↓
4. As necessary, repeat Steps 2 and 3.
↓
5. The voice command is carried out.

- ☞ With the “CD-SR80” Steering Remote Controller (sold separately), you can press the BAND button and the F button to switch on the operation mode of the Steering Remote Controller. When the operation mode is switched on, by pressing the BAND button of the Steering Remote Controller, you can activate voice operation, which is equivalent of pressing the TALK button.
- ☞ When your Navigation System starts, you can also enter the password using your voice.

■ Available voice commands

When your car is parked with the handbrake on, press the TALK button to display a list of available voice commands (Voice Help menu). Display of the Voice Help menu can be turned on /off with “Voice Recognition Help” in the Settings menu.

When you speak one of the commands in the list; the command is carried out.

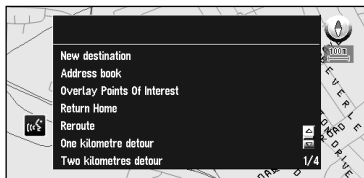

When voice command is possible



When voice command is not accepted.

- While you are still learning voice operation features, and want to use voice commands, it is recommended that you first park your car in a safe place and look at the commands shown by the Voice Help menu.

When all the voice commands cannot be shown in one screen

To scroll through the rest of the menu, simply use the scale controller.

To continue to use voice operation, press the TALK button and speak a command.

- When you are used to voice operation features and no longer need Voice Help, you can switch it off. For details, see “Voice Recognition Help” on page 89.

To cancel voice operation

You can cancel voice operation features at any time by pressing the NAVI button or pressing the TALK button downwards. After you cancel voice operation, the map is displayed.

■ An example of voice operation

When using the voice command, it is important to get the timing correct. Before speaking, you must first wait for the “Please make your request” message. This is followed by a Beep tone to indicate it is now your turn to speak. In this example, you want to search for the nearest petrol station. When presented with a list of search options, you say the number to the left of the result that you want to select.

1 Press the TALK button.

A list of commands for voice operation appears. After the “Please make your request” message, the beep indicates that the system is ready to accept your voice command. You say a command after this beep.

- If no command is made in the next 6 seconds, voice recognition is cancelled and the Navigation System is on hold until the next operation. Press the TALK button to reactivate voice operation.
- If you want to listen to the message of the Navigation System, say “Repeat”.

2 Say “New Destination”.

Speak all commands towards the microphone. If the voice command is recognised, the command appears on the screen, and the system voice repeats it. Then, a message to prompt the next operation is given.

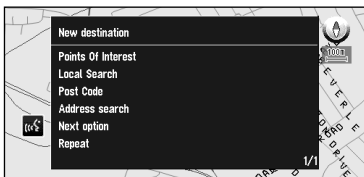
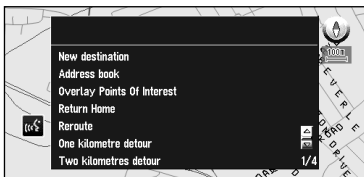

3 Say “Local search”.

You say the contents you want to operate. Here, selection method of your destination is specified. When you want to search the petrol station nearest to the current location, say “Local search”. When you speak the command, the Navigation System displays the command it recognised and the system voice repeats it.

☞ If a command that you did not intend is recognised, press the TALK button or say “Next option”. Other available commands are then shown. If you then press the TALK button within 3 seconds, yet more commands are shown. Repeat this until the command you want to use is shown.

4 Say “Petrol station”.

The map of the nearest petrol station is shown. The message, “Do you want to stop in?” follows.

5 After confirming the location, say “Yes”.



With the location shown on the map set as the destination, the route calculation starts.

☞ If you want to see maps with other options, at Step 5 say “Next”.

☞ At Step 5, if you say “No”, you cancel voice operation and the map is displayed.

To spell out characters and symbols

When entering city names, names of POIs, or postcodes, speak one character at a time. For example, if you want to enter “A”, say “Alpha”.

	Pronunciation		Pronunciation		Pronunciation		Pronunciation		Pronunciation
1	One	A	Alpha	K	Kilo	U	Uniform	_	Space
2	Two	B	Bravo	L	Lima	V	Victor	-	Hyphen
3	Three	C	Charlie	M	Mike	W	Whiskey	'	Apostrophe
4	Four	D	Delta	N	November	X	X-Ray	&	And
5	Five	E	Echo	O	Oscar	Y	Yankee	/	Slash
6	Six	F	Foxtrot	P	Papa	Z	Zulu	.	Full stop
7	Seven	G	Golf	Q	Quebec			,	Comma
8	Eight	H	Hotel	R	Romeo			\$	Dollar
9	Nine	I	India	S	Sierra			+	Plus
0	Zero	J	Juliet	T	Tango			“	Quotation mark

To finish the entry by spelling and to make the Navigation System display a list of options

To finish entry of the spelt-out name of a city, POI, or postcode, say “Verify”. A list of relevant items is displayed.

1 After inputting some characters, say “Verify”.

A list of items matching the entry appears. Each item has a matching number on the left.

- If all items cannot be shown on one screen, say “Next page” to display the following page. Say “Previous page” to return to the previous page.
- If no possible item is found, the display returns to the previous page.

2 Say the number of the item you want.



The map of the selected location appears on the display. The message, “Do you want to stop in?” follows.

3 If you want to select this location as your destination, say “Yes”.



Route calculation starts with the location displayed on the map as your destination.

- If you want to see the maps with other options, say “Next option”.
- If you say “No”, voice operation is cancelled, and the map is displayed.

Tips for Voice Operation

For your voice commands to be correctly recognised and interpreted, ensure that conditions are suitable for recognition.

Reduce the volume setting on your car audio system

The voice recognition system may have problems distinguishing your voice commands from background noise. Turn down your audio system: remember that voices on the radio might be interpreted as commands.

Close the vehicle windows

Just as your audio system may interfere with voice operation, so can wind noise caused by open windows and sounds entering from outside. If you have problems with voice recognition, try closing the vehicle windows.

Position the microphone carefully

For optimum pick-up, the microphone should be fixed at a suitable distance directly in front of the driver. Make sure that you do not need to alter your position or look away from the road ahead when giving voice commands; not only is this awkward, but it can also compromise driving safety. Bear this in mind when choosing where to attach the microphone.

Pause before giving a command

After pressing the TALK button on the Remote Controller, pause for a moment after the confirmation beep before giving your command. Speaking too soon may cause the recognition to fail. If you still experience recognition problems, leave a slightly longer pause before giving a command.

Pronounce your commands carefully

Speak slowly, deliberately and clearly. Fast or mumbled commands are easily misinterpreted. If the microphone is properly positioned, there is no need to raise your voice when giving commands.

- ☞ If you have a Pioneer Head Unit with a muting function (one that has an Yellow/black lead), the volume will automatically be reduced when you give a voice command.

Appendix

Positioning Technology

The Navigation System accurately measures your current location by combining the positioning by GPS and by Dead Reckoning.

Positioning by GPS

The Global Positioning System (GPS) uses a network of satellites orbiting the Earth. Each of the satellites, which orbit at a height of 21,000 km, continually broadcasts radio signals giving time and position information. This ensures that signals from at least three can be picked up from any open area on the earth's surface.

The accuracy of the GPS information depends on how good the reception is. When the signals are strong and reception is good, GPS can determine latitude, longitude, and altitude for accurate positioning in three dimensions. But if signal quality is poor, only two dimensions, latitude and longitude, can be obtained and positioning errors are somewhat greater.

Positioning by dead reckoning

The 3D Hybrid Sensor in the main unit also calculates your position. The current location is measured by detecting driving distance with the speed pulse, the turning direction with the Gyrosensor, and inclination of the road with the G sensor.

The 3D Hybrid Sensor can even calculate changes of altitude, and corrects for discrepancies in the distance travelled caused by driving along winding roads or up slopes. Also, the Navigation System learns the driving conditions and stores information in the memory; thus, as you drive more, the precision of the positioning becomes more accurate.

The method of positioning changes as follows depending on whether the speed pulse of your vehicle is detected or not:

3D hybrid mode

This is active when the speed pulse is detected. Inclination of a street can be detected.

Simple hybrid mode

When the speed pulse is not detected, positioning is performed in this mode. Only horizontal movement is detected, so it becomes less accurate. Also, when the positioning by GPS is not available, such as when your vehicle enters a long tunnel, the discrepancy between your actual and calculated position may become bigger.

☞ The speed pulse data comes from the speed sensing circuit. The location of this speed sensing circuit depends on your vehicle model. In some cases, it is impossible to make a connection to it, and in such a case we recommend that the ND-PG1 speed pulse generator (sold separately) be used.

How do GPS and dead reckoning work together?

For maximum accuracy, your Navigation System continually compares GPS data with your estimated position as calculated from the data of 3D Hybrid Sensor. However, if only the data from the 3D Hybrid Sensor is available for a long period, positioning errors are gradually compounded until the estimated position becomes unreliable. For this reason, whenever GPS signals are available, they are matched with the data of the 3D Hybrid Sensor and used to correct it for improved accuracy.

To ensure maximum accuracy, the dead reckoning system learns with experience. By comparing the position it estimates with your actual position as obtained using GPS, it can correct for various types of error, such as tyre wear and the rolling motion of your vehicle. As you drive, the dead reckoning system gradually gathers more data, learns more, and the accuracy of its estimates gradually increases. So, after you have driven some distance, you can expect your position as shown on the map to show fewer errors.

- If you use chains on your wheels for winter driving, or if you put on the spare wheel, the errors may appear to suddenly increase because of the increased wheel diameter. To prevent the contamination of previously acquired learning data, learning automatically stops when such errors suddenly appear.
- There are two learning memories, so the Navigation System can learn about and compensate for two different tyre sets, such as summer and winter tyres (see “Checking sensor learning status and driving status” on page 82 for details).

Map matching

As mentioned, the GPS and dead reckoning systems used by this Navigation System are susceptible to certain errors. Their calculations may, on occasion, place you in a location on the map where no road exists. In this situation, the processing system understands that vehicles travel only on roads, and can correct your position by adjusting it to a nearby road. This is called map matching.

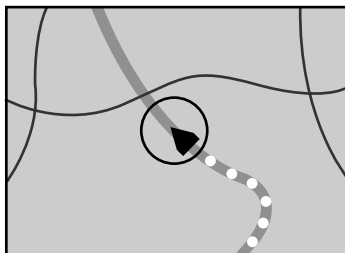

With map matching

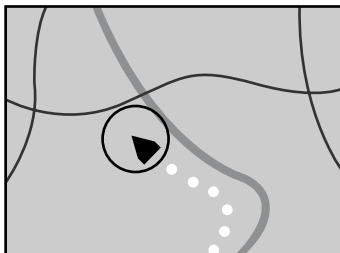

Without map matching

Handling Large Errors

Positioning errors are kept to a minimum by combining GPS, Dead Reckoning, and map matching. However, in some situations, these functions may not work properly, and the error may become bigger.

■ When the positioning by GPS is impossible

- If signals cannot be received from more than two GPS satellites, GPS positioning does not take place.
- In some driving conditions, signals from GPS satellites may not reach your vehicle. In this case, it is impossible for the system to use GPS positioning.



In tunnels or enclosed parking garages

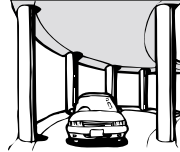

Under elevated roads or similar



When driving among high buildings



When driving through a dense forest or tall trees

- If a car phone or cellular phone is used near the GPS aerial, GPS reception may be lost temporarily.
- Do not cover the GPS aerial with spray paint or car wax, because this may block the reception of GPS signals. Snow buildup can also degrade the signals, so keep the aerial clear.

☞ If, for any reason, GPS signals cannot be received, learning and error correction are not possible. If GPS positioning has been operating for only a short time, your vehicle's actual position and the current location mark on the map may diverge considerably. Once GPS reception is restored, accuracy will be recovered.

■ **Conditions likely to cause noticeable positioning errors**

Certain conditions are more likely to cause discrepancies between your actual position and the location shown on the map display.

- If you make a slight turn
- If there is a parallel road
- If there is another road very nearby, for example, an elevated motorway
- If you take a recently opened road that is not on the map
- If you drive in zig-zags
- If the road has connected hairpin bends
- If there is a loop or similar road configuration
- If you take a ferry
- If you are driving on a long, straight road or a gently curving road
- If you are on a steep mountain road with many height changes
- If you enter or exit a multi-storey car park or similar with a spiral layout
- If your vehicle is turned on a turntable or similar
- If your vehicle's wheels spin, such as on a rough track or in snow
- If you put on chains, or change your tyres for some of a different size
- If trees or other obstacles block the GPS signals for a considerable period
- If you drive very slowly, or in a start-and-stop manner, as in a traffic jam
- If you join the road after driving around a large car park
- When you go round a roundabout
- When starting driving immediately after starting the engine
- If you insert the disc and turn your Navigation System on while driving

Some types of vehicle may not output a speed signal while driving at just a few kilometres per hour. In such a case, the current location of your vehicle may not be displayed correctly while in a traffic jam or in a car park.

Handling and Care of the Disc

Some basic precautions are necessary when handling your discs.

Discs you can use

- Use only the disc provided for use with this unit. You cannot use ordinary DVDs, CD-ROMs, or music CDs.
- Do not try to use a disc that is cracked, scratched or bent.
- This product is designed for use with conventional, fully circular discs only. Use of shaped discs is not recommended for this product.

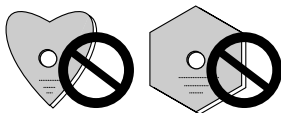

Precautions for handling

- Do not touch the playing surface of a disc. Hold the disc carefully by its outer edge or by the hole in the centre.
- Do not attach sticky tape or suchlike to the surfaces of a disc. Avoid scratching the disc, or damaging it in any way.

About cleaning

- Keep your disc clean and free of dust. If you need to clean a disc, use a soft, lint-free cloth to wipe the surface from the centre outward, as shown.

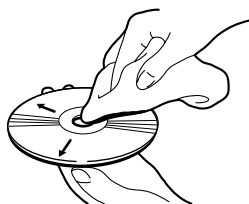

- Never apply solvents to your disc, such as benzene, thinner, commercial cleaners, or anti-static fluids intended for vinyl records.

Precautions for storage

- Keep your disc away from direct sunlight, sources of heat, and sources of dust. Store the disc in its protective case to provide greater protection against warping.

Ambient conditions for playing disc

Ambient conditions can affect the behaviour of discs and the operation of the system.

- Vibrations caused by driving may sometimes interrupt the reading of data from the disc, causing slow screen changes.
- In cold weather, condensation may form on the optical lens used to read the disc or on the disc itself, particularly when the vehicle initially warms up. This may render the disc unreadable for up to an hour as the moisture evaporates naturally. You may wipe condensation of a disc with a soft cloth (from the centre outward).
- At extremely high temperatures, a temperature cutout protects the Navigation System by switching it off automatically.
- Despite our careful design of the product, as a result of mechanical wear, ambient conditions for use, or handling of the disc, small scratches that do not affect actual operation may appear on the disc surface. This is not a sign of the malfunction of the unit. Consider it to be normal wear and tear.

Resetting the System

On occasion, you may need to reset your Navigation System.

When a reset is necessary

You should reset the system in the following situations:

- After installation of this unit in your vehicle.
- If there appear to be problems with the operation of the system.
- If there are problems with the display.

Using the reset button

The reset button is recessed in the front of the main unit to prevent accidental use. You can see it in the top right corner of the front panel.

Insert a pointed implement such as a ballpoint pen into the small hole and push.

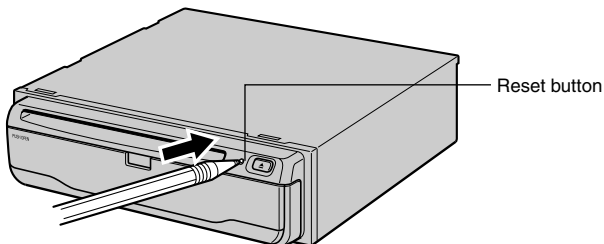

Troubleshooting

If you have problems operating your Navigation System, refer to this section. The most common problems are listed below, along with likely causes and solutions. While this list is not comprehensive, it should answer your most pressing problems. If a solution to your problem cannot be found here, contact your dealer or the nearest authorised Pioneer service facility.

You cannot position your vehicle on the map or the positioning error is large.

Possible causes:

- (1) The quality of signals from the GPS satellites is poor, causing reduced positioning accuracy. Such a loss of signal quality may happen for the following reasons:
 - The GPS aerial is in an unsuitable location.
 - Obstacles are blocking signals from the satellites.
 - The position of satellites relative to your vehicle is bad.
 - Signals from the GPS satellites have been modified to reduce accuracy. (GPS satellites are operated by the US Department of Defense, and the US government reserves the right to distort positioning data for military reasons. This may lead to greater positioning errors.)
- (2) Signals from the vehicle's speed pulse are not being picked up properly.
- (3) The main unit may not be mounted securely in your vehicle.
- (4) Your vehicle is operating in Simple hybrid mode (see "Positioning by dead reckoning" on page 97).
- (5) Setting of attachment direction lever is wrong.
- (6) Main unit is installed with extreme angle exceeding the limitation of the installation angle.

Solutions:

- (1) Check the GPS signal reception using "GPS Status" (see "Checking positioning information by satellite" on page 81) and the position of the GPS aerial if necessary, or continue driving until reception improves.
- (2) Check that the cables are properly connected. If necessary, consult the dealer that installed the system.
- (3) Check that the main unit is securely mounted and, if necessary, consult the dealer that installed the system.
- (4) Connect the speed signal input (pink lead wire) of the power wire correctly, and reset the 3D Hybrid Sensor.
- (5) Check the attachment position of the main unit of your Navigation System and the setting of the attachment direction lever (see the "Installation Manual").
- (6) Confirm the installation angle. (This unit must be installed within +30 degrees to -15 degrees of the horizontal, or within five degrees of your vehicle's direction of travel.)

The map continually reorients itself.

Possible causes:

The display is set to "Heading Up".

Solutions:

Check the "Map Orientation" settings (see "Map Orientation" on page 88) and change the setting to "North Up".

Tracking marks are not displayed.

Possible causes:

The "Tracking Display" is turned off.

Solutions:

Check the "Tracking Display" settings (see "Tracking Display" on page 88) and make sure "ON (permanently)" or "ON (current journey)" is selected.

The daylight display is used even when the vehicle lights are on.

Possible causes:

- (1) “Day Display” is selected on “Map Display.”
- (2) The Orange/white lead is not connected.

Solutions:

- (1) Check the “Map Display” setting (see “Map Display” on page 88) and make sure “Illumination” is selected.
- (2) Check connection.

The system will not switch on or will not operate.

Possible causes:

Installation or connection has been carried out incorrectly.

Solutions:

Check with your dealer.

The display is very dim.

Possible causes:

- (1) The vehicle’s light is turned ON, and “Illumination” is selected on “Map Display”.
- (2) The vehicle cabin temperature is extremely low.

Solutions:

- (1) Read about the “Map Display” setting (see “Map Display” on page 88) and, if desired, select “Day Display”.
- (2) A Liquid Crystal Display (LCD) is used, and such displays tend to darken when cold. Wait for the vehicle to warm up.

There is no voice guidance or the volume is low.

Possible causes:

The volume setting is low.

Solutions:

Check the volume setting on the display or turn the volume up according to “Hardware Volume” (see “Hardware Volume” on page 88) and/or turn up the volume on the display.

The Remote Controller fails to work.

Possible causes:

- (1) The batteries are low.
- (2) The batteries have been inserted incorrectly.
- (3) The Remote Controller is pointing at the floor or a seat.
- (4) The signal receptor on the display is exposed to direct sunlight.
- (5) The Mode switch of the Remote Controller is not set correctly.

Solutions:

- (1) Change the batteries.
- (2) Check that the batteries are properly inserted according to the + and - markings.
- (3) Ensure that the Remote Controller has a clear line of sight to the display unit.
- (4) Move the Remote Controller closer to the receiver on the display unit.
- (5) Set the Mode switch of the Remote Controller correctly (see “Selecting dipswitches” on page 15).

The image sways

Possible causes:

The setting of “Monitor Type” on the Settings menu is not appropriate.

Solutions:

Change the setting of “Monitor Type” (see “Monitor Type” on page 88) to the different setting.

When the screen is frozen...

Park your vehicle at a safe place, and cut the engine off. Turn the ignition key back to “Acc off”. Then start the engine again, and turn the power to the main unit back on. If this does not solve the problem, press the reset button on the main unit.

Messages and how to react to them

The following messages may be displayed by your Navigation System.

- ☞ There are occasions when you may see error messages other than those shown here. In such a case, follow the instructions given on the display.

(1) "You cannot use this function while driving."

When:

While trying to make a menu selection.

What to do:

Pull over and come safely to a halt, put the handbrake on, and then try again.

(2) "This is not the appropriate disc. Please insert the appropriate disc."

When:

- (1) If you try to use a disc which is incompatible with this system.
- (2) If you insert a disc upside down.
- (3) If the disc is dirty.
- (4) If the disc is cracked or otherwise damaged.

What to do:

- (1) Insert a suitable disc.
- (2) Insert the disc with the label upward.
- (3) Clean the disc.
- (4) Consult your dealer.

(3) "Irregular speed pulse signal is detected. Please turn system power off and check the installation. After checking, please re-boot the system."

When:

If the Navigation unit does not receive the vehicle speed pulse.

What to do:

Consult your Pioneer dealer.

(4) "Speed pulse wire is not connected. Please be sure to connect the system to the speed pulse wire. Accuracy is not fully ensured without speed pulse."

When:

The speed signal input (pink lead wire) of the power wire is not connected.

What to do:

To operate with 3D hybrid mode, connect the speed signal input (pink lead wire) of the power wire correctly. Although it can be operated with Simple hybrid mode without connecting the speed signal input, the precision of the positioning will be less accurate (see "Positioning by dead reckoning" on page 97).

(5) "Vibration is detected. Please turn system power off and check the installation. After checking, please re-boot the system and press "OK"."

When:

While the car is stationed, the Navigation System is installed at the place where the main unit may be affected by a large vibration.

What to do:

Re-install the main unit of the Navigation System to the place where the main unit will not be affected by vibration.

(6) "Direction of G sensor is not correct. Please turn system power off and check the installation. After checking, please re-boot the system and press "OK". Please check installation, then press "OK"."

When:

Direction of G sensor is set incorrectly.

What to do:

See the "Installation Manual" and set the direction of G sensor correctly.

(7) "Gyro Sensor is not working properly. Please consult your dealer or Pioneer service center."

When:

Abnormal output of Gyrosensor is detected.

What to do:

Note down the error code shown on the screen; turn off the power, and then contact your nearest Pioneer service facility.

(8) "Your route could not be found."

When:

If the distance to the destination is too far and cannot be set.

What to do:

Change the destination to a location that is closer and divide up the route.

(9) "You cannot set more via points. Please delete current via point and re-enter to set new via point."

When:

If you try to set more than five via points.

What to do:

Add the next via point after arriving at your first via point. Or, after deleting an unnecessary via point, add a new via point.

(10) "Your journey cannot avoid the specified area."

When:

If route setting cannot avoid a specified Area to Avoid.

What to do:

Choose whether or not to try setting a route through the area.

(11) "More than 6 characters are required."

When:

If you enter a name of six characters or less for a registered location or a listing in the Address Book.

What to do:

Use a name with more than six characters.

(12) "Memory full."

When:

If there are already 50 ticked items when you attempt to add a tick in the Address Book.

What to do:

Remove the tick from some destinations as appropriate.

(13) "Memory full."

When:

When there is no more free space in the PC card.

What to do:

Delete unnecessary data.

(14) "Initialisation failed. Back to PC card menu automatically."

When:

Your Navigation System could not initialise the PC card for some reason.

What to do:

Try the initialisation again. If it still does not work, there may be some problems on the PC card.

(15) "Irregular character strings. Please input again."

When:

A symbol you cannot pronounce was entered (during password registration).

What to do:

Enter a word that you can pronounce.

(16) "An error has occurred. Please note the following error code and power off."

When:

In the case of a system failure.

What to do:

Note down the error code shown on the screen; turn off the power, and then contact your nearest Pioneer service facility.

(17) "Player overheating. Discontinue until temperature drops."

When:

The DVD-ROM drive has overheated.

What to do:

Cut the power off, and wait for a while before turning the power on again.

☞ When the messages other than above are displayed, follow the instructions on the display.

Route Setting Information

■ Route search specifications

Your Navigation System sets a route to your destination by applying certain built-in rules to the map data. This section provides some useful information about how a route is set.

Caution

When a route is calculated, the route and voice guidance for the route is automatically set. Also, for day or time traffic regulations, only information about traffic regulations at the time when the route was calculated is shown. For example, if a street is open during the morning only, but you arrive later, it would be against the traffic regulations so you cannot drive along the set route. When driving, please follow the actual traffic signs. Also, the system may not know some traffic regulations.

- The calculated route is one example of the route to your destination decided by the Navigation System whilst taking the type of streets or traffic regulations into account. It is not necessarily an optimum route. (In some cases, you may not be able to set the streets you want to pass. If you want to pass a certain street, set the via point on that street.)
- The route set by your Navigation System is based on the assumption that the driver does not know the area. Thus, the streets known to local drivers, such as small streets or special roads, may not be used for the set route.
- If there are fewer than six recommended routes, some route options may become the same route. If visiting points are set, only one route is calculated.
- Route setting is limited to the range of the disc in use. Additionally, if the destination is too far, there may be instances where the route cannot be set. (If you want to set a long-distance route going across several areas, set via points along the way.)
- If you try to select a point on a motorway as a destination, a location on a nearby road (such as below the motorway) may be chosen instead.
- During voice guidance, turns and junctions from motorway are automatically announced. (However, if you pass junctions, turns, and other guide points in rapid succession, some may not be announced.)
- Incorrect guidance may be given at motorway junctions if the exit lane is particularly long.
- It is possible that guidance may direct you off a motorway and then back on again.
- If a route along a normal motorway passes near a motorway service area, the system may mistake the service area for a motorway junction.
- In some cases, the set route may require you to travel in the opposite direction to your current heading. In such cases, you are instructed to turn around, so please turn around safely by following the actual traffic rules.
- In some cases, guidance may direct you past your destination and then indicate a U-turn to get back to it.
- In some cases, a route may begin on the opposite side of a railway or river from your actual current location. If this happens, drive towards your destination for a while, and try route calculation again.
- In the following cases, the route that passes through an Area to Avoid may be set:
 - when your vehicle is in the Area to Avoid
 - when your destination or via points are in the Area to Avoid
 - when it is not possible to avoid doing so
- If a suitable route cannot be set in compliance with the specified “Detour” parameter or your preference to avoid motorways or a ferry route, the setting or parameter may be ignored.
- When there is a traffic jam ahead, if driving through the traffic jam is better than taking the detour, a detour route may not be set.
- If your destination is a motorway junction, voice guidance may not announce the junction.
- There may be instances when the starting point and the destination point are not on the highlighted route.

- When calculating a route to return to the original route, the shortest way back to the original route is found. It may take you along winding roads, narrow city streets, and other non-optimum roads.
- “Auto Reroute” function does not work in the following cases:
 - when your car is not on a street
 - when your car is on a ferry
 - when driving on a road inside a facility
 - when driving on a roundabout

■ **Route highlighting**

Once set, the route is highlighted in bright green on the map.

- On major motorways and wide roads, where a road is on multiple levels, or in mountainous areas with many hills and curves, the highlighted route may not coincide exactly with the map.
- The immediate vicinity of your starting point and destination may not be highlighted, and neither will areas with particularly complex road layouts. Consequently, the route may appear to be cut off on the display, but voice guidance will continue.
- In Driver’s view, the route displayed may be different from the actual shape of the streets, and the route may seem to protrude from the streets in the following locations:
 - near your destination, departure point, or via points.
 - near the mark indicating your vehicle when route is recalculated with Auto Reroute function and suchlike.

■ **Intersection enlargement**

As you approach an intersection, the map scale increases to show more detail.

- When the map scale increases, your vehicle direction immediately before reaching the intersection is shown as “UP”. Thus, if you approach the intersection in a straight line, the current location mark will come onto the map from the bottom of the display. If the road curves into the intersection, the current location mark will enter the intersection from the side.
- If the intersection is approached in a gentle curve, the map displayed may differ from the actual road layout.

■ **Tracking**

Your Navigation System marks your course on the map in certain increments. This is called tracking. It is handy when you want to check a route travelled without guidance or if returning along a complex route. A maximum of about 200 km (124 miles) is marked and, as you travel beyond this limit, tracking marks are erased in order from the most distant. Tracking can also be set for automatic erasing whenever the Navigation System is switched off (see “Tracking Display” on page 88).

■ **About traffic information**

- Because the information is updated only periodically, it may take time to collect all the information.
- Not all RDS stations provide traffic information.
- Traffic information is not taken into account in calculating estimated time of arrival time or travel time for your destination.
- This product may not be able to receive traffic information in some areas.

- Pioneer does not bear responsibility for the accuracy of the information transmitted.
- Pioneer does not bear responsibility for changes to information services provided by broadcasting stations or by related companies, such as cancellation of the services or changing to pay-services. Also, we do not accept return of the product for this reason.

Copyright

©1993-2000 Navigation Technologies B. V. All rights reserved

France:

Sourcé: GéoRoute® IGN France & BD Carto® IGN France

Germany:

Die Grundlagendaten wurden mit Genehmigung der zuständigen Behörden entnommen.

Great Britain:

Based upon Ordnance Survey electronic data and used with the permission of the Controller of Her Majesty's Stationary Office © Crown Copyright, 1995

Italy:

La Banca Dati Italiana é stata prodotta usando quale riferimento anche cartographia numerica ed al tratto prodotta e fornita dalla Regione Toscana.

Portugal:

“Source: IgeoE-Portugal”

Spain:

Información geográfica propiedad del CNIG.

Sweden:

Based upon electronic data © National Land Survey Sweden.

Switzerland:

Topografische Grundlage: © Bundesamt für Landestopographie.

© 2001 DENSO CORPORATION, All rights reserved

© 2001 Lernout & Hauspie Speech Products N. V. All rights reserved



The Speech & Language Company

Specifications

Main unit

(GPS receiver)

System	: L1, C/Acode GPS SPS (Standard Positioning Service)
Reception system	: 8-channel multi-channel reception system
Reception frequency	: 1,575.42 MHz
Sensitivity	: -130 dbm
Position update frequency	: Approx. once per second

(Common)

Max. output impedance	: 1Vp-p, 75Ω
Maximum current consumption	: 2.0 A
Power source	: DC 14.4V (10.8 - 15.1V allowed)
Ground type	: Negative type

GPS aerial

Aerial	: Micro strip flat aerial/ right-handed helical polarization
Aerial cable	: 5.0 m

Dimensions

Main unit	: 200(W) × 52(H) × 209(D) mm
GPS aerial	: 46(W) × 46(H) × 13(D) mm
Remote controller	: 38(W) × 145(H) × 30(D) mm

Weight

Main unit	: 2.1 kg
GPS aerial	: 130g
Remote controller	: 80g (including battery)

Note:

- The specifications and design are subject to change without prior notice. The product purchased may differ in detail from illustrations in this manual.

Glossary

This glossary explains some of the terms used in the manual.

3D Hybrid sensor

The built-in sensor which enables the system to estimate your vehicle's position. A learning function increases its accuracy and two sets of learning data can be stored in memory.

Address Book

A list of previously searched destinations, via points and locations registered manually.

Current location

The present location of your vehicle; your current location is shown on the map by a red triangle mark.

Default setting

A factory setting which applies when you first switch on the system; you can change default settings to suit your own needs in the Settings menu.

Destination

A location you choose as the end point of your journey.

DVD-ROM

A disc used to store data.

Favourite location

A frequently visited location (such as your workplace or a relative's home) that you can register to allow easy routing.

GPS

Global Positioning System. A network of satellites that provides navigation signals for a variety of purposes.

Guidance mode

The mode in which guidance is given as you drive to your destination; the system automatically switches to this mode as soon as a route has been set.

Guidance point

These are important landmarks along your route, generally intersections. The next way point along your route is indicated on the map by the yellow flag icon.

Home location

Your registered home location.

Joystick

The main control on the Remote Controller; it is used extensively to make selections from menus and to scroll the map display.

Menu

A list of options shown on the display; choices are selected using the joystick.

PC card

Card-type peripheral equipment mainly used for personal computers. The Navigation System can use a memory card to store data.

Point of Interest (POI)

Point Of Interest; any of a range of locations stored in the data, such as railway stations, shops, restaurants, and amusement parks.

RDS-TMC

A communication system for informing drivers of the latest traffic information using FM multiplex broadcast. Information such as traffic jams or accidents can be checked on the display.

Remote Controller

The remote control unit for the system (see "The Remote Controller" on page 17).

Route setting

The process of determining the ideal route to a specific location; route setting is done automatically by the system when you specify a destination.

Set route

The route marked out by the system to your destination. It is highlighted in bright green on the map.

Tracking

Marks on the map indicating the route you have travelled.

Via Point

A location that you choose to visit before your destination; a journey can be built up from multiple via points and the destination.

Voice guidance

The giving of directions by a recorded voice while in guidance mode.

Voice recognition

The technology that allows the system to understand the driver's voice commands.

Display Information

Main menu

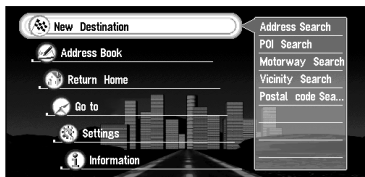

- New Destination
- Address Book
- Return Home (P.45, 68)
- Go to ~ (P.45, 68)
- Settings
- Information



New Destination menu



- Address Search (P.28, 46)
- POI Search (P.49)
- Motorway Search (P.52)
- Postal code Search (P.51)
- Vicinity Search (P.50)

Address Book menu

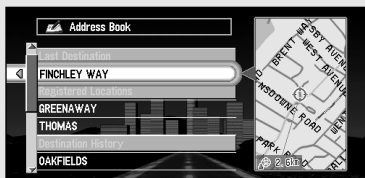

- Last Destination (P.63)
- Registered Location (P.63)
- Destination History (P.63)

Address Book operation menu



- Information/Edit (P.65)
- Registration (P.63)
- Delete This Item (P.67)
- Delete All Destinations (P.67)
- Delete All Address Book (P.67)
- View Map (P.67)

Settings menu

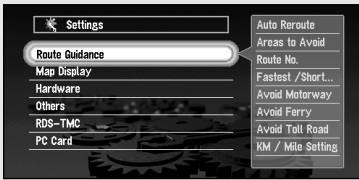

Route Guidance menu (1)

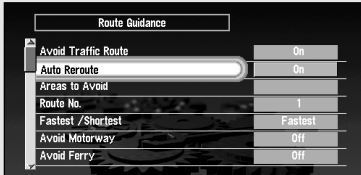

Route Guidance menu (2)

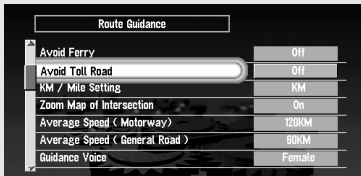

Map Display menu

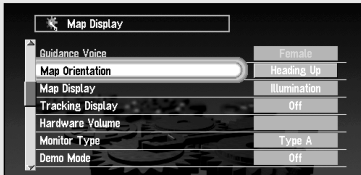

Hardware menu

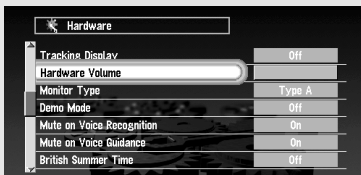

Others menu (1)

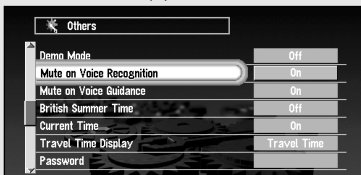

Route Guidance (P.86)
 Map Display (P.88)
 Hardware (P.88)
 Others (P.88)
 RDS-TMC (P.90)
 PC-Card (P.78)

Auto Reroute (P.86)
 Areas to Avoid (P.72)
 Route No. (P.42, 86)
 Fastest/Shortest (P.43, 86)
 Avoid Motorway (P.43, 86)
 Avoid Ferry (P.86)

Avoid Toll Road (P.87)
 KM/Mile Setting (P.87)
 Zoom Map of Intersection (P.87)
 Average Speed (Motorway) (P.87)
 Average Speed (General Road) (P.87)
 Guidance Voice (P.87)

Map Orientation (P.88)
 Map Display (P.88)
 Tracking Display (P.88)

Hardware Volume (P.88)
 Monitor Type (P.88)

Demo Mode (P.88)
 Mute on Voice Recognition (P.88)
 Mute on Voice Guidance (P.89)
 British Summer Time (P.23, 89)
 Current Time (P.89)
 Travel Time Display (P.89)
 Password (P.71, 89)

Others menu (2)



Help Menu (P.89)
 Voice Recognition Help (P.89)
 Language selection (P.22, 90)
 Return Home (P.45, 68)
 Go to~ (P.45, 68)
 Modify Current Location (P.90)
 Adjust Display Position (P.90)

RDS-TMC menu

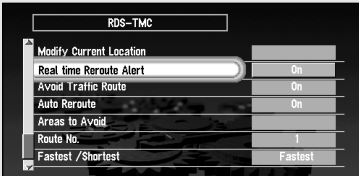

Real Time Reroute Alert (P.90)
 Avoid Traffic Route (P.90)

PC Card menu

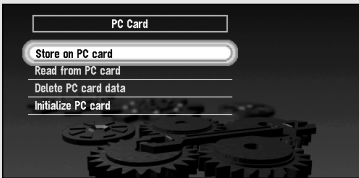

Store on PC card (P.78)
 Read from PC card (P.79)
 Delete PC card data (P.80)
 Initialize PC card (P.78)

Information menu

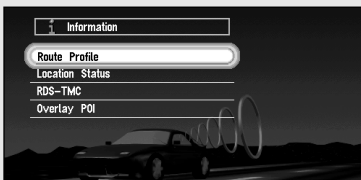

Route Profile (P.56)
 Location Status (P.81)
 RDS-TMC (P.74)
 Overlay POI (P.62)

Location Status menu

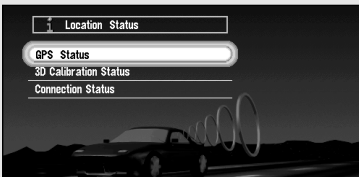

GPS Status (P.81)
 3D Calibration Status (P.82)
 Connection Status (P.83)

RDS-TMC menu

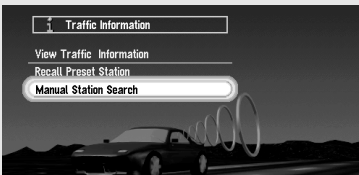

View Traffic Information (P.74)
 Recall Preset Station (P.77)
 Manual Station Search (P.76)



Appendix



MEMO

Write your registered password here; remove this page from the manual, and store it in a safe place.

CAUTION: Never leave any note of your password in your vehicle.

PIONEER CORPORATION

4-1, MEGURO 1-CHOME, MEGURO-KU, TOKYO 153-8654, JAPAN

PIONEER ELECTRONICS (USA) INC.

P.O. Box 1760, Long Beach, California 90801, U.S.A.
TEL: (800) 421-1404

PIONEER EUROPE NV

Haven 1087, Keetberglaan 1, B-9120 Melsele, Belgium
TEL: (0) 3/570.05.11

PIONEER ELECTRONICS AUSTRALIA PTY. LTD.

178-184 Boundary Road, Braeside, Victoria 3195, Australia
TEL: (03) 9586-6300

PIONEER ELECTRONICS OF CANADA, INC.

300 Allstate Parkway, Markham, Ontario L3R OP2, Canada
TEL: (905) 479-4411

PIONEER ELECTRONICS DE MEXICO, S.A. de C.V.

San Lorenzo 1009 3er. Piso Desp. 302
Col. Del Valle Mexico, D.F. C.P. 03100
TEL: 5-688-52-90

Published by Pioneer Corporation.
Copyright © 2001 by Pioneer Corporation.
All rights reserved.

Publication de Pioneer Corporation.
Copyright © 2001 Pioneer Corporation.
Tous droits de reproduction et de traduction
réservés.